



MENTOR® MemoryShape® RESTERILIZABLE GEL BREAST IMPLANT SIZER STERILE

ENGLISH

112009-001 Rev A Effective May 2017
LAB100300459v2

Caution: Federal (U.S.A.) law restricts this device to sale by or on the order of a licensed healthcare practitioner.

DESCRIPTION

MENTOR® MemoryShape® Resterilizable Gel Breast Implant Sizer (Gel Sizer) is a sizing device designed for temporary intraoperative placement to assist in evaluating the appropriate breast implant size and shape for each patient prior to implantation of a MENTOR® MemoryShape® Breast Implant.

The Gel Sizer is not intended as an implantable device. The Gel Sizers are specifically labeled “Not for Implant”.

The smooth surface of the Gel Sizer shell is made with a silicone elastomer shell filled with Mentor’s proprietary formulation for silicone gel. The device is designed with successive cross-linked layers of silicone elastomer, each cross-linking layer uniting with the last to provide the device with elasticity and integrity. **The Gel Sizer is provided STERILE** for the first use, and must be resterilized prior to each subsequent use. The Gel Sizer can be resterilized up to nine (9) times after the first use for a total of ten (10) uses, after which you must discard the device.

MemoryShape® sizers are offered in various styles and sizes to match the corresponding MemoryShape® breast implants. These Gel Sizers contain raised orientation marks on the anterior and posterior of the device. These marks help the physician orient the sizer and ensure proper placement during intraoperative insertion (Figure 1).

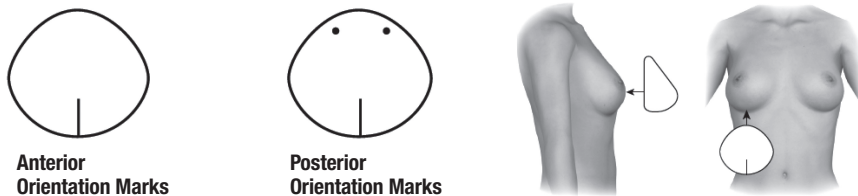

Figure 1. Orientation Marks on MemoryShape® Sizers

INDICATIONS

The Gel Sizer is indicated for use for **temporary insertion** intraoperatively to evaluate the size and shape of the MemoryShape® Breast Implant to be implanted.

Prior to using the Gel Sizer, the physician should be familiar with all of the literature associated with MemoryShape® Breast Implants.

CONTRAINDICATIONS

The use of this Gel Sizer as a long-term breast implant is contraindicated.

WARNINGS

It is the exclusive responsibility of the surgeon, and Mentor relies on the surgeon, to advise the patient of all potential risks and complications associated with the proposed surgical procedure and device, including providing a comparison of the risks and complications of alternative procedures. **Prior to surgery, the surgeon should also be familiar with all WARNINGS, PRECAUTIONS, and ADVERSE REACTIONS associated with the use of the breast implant to be implanted.** The following **WARNINGS** regarding the Gel Sizer are intended to supplement the **WARNINGS** listed in the **Product Insert Data Sheet** for the breast implant to be used.

The Gel Sizer must not be used as a long-term breast implant or tissue expander.

DO NOT resterilize the device more than nine (9) times.

DO NOT insert or attempt to repair a damaged Gel Sizer.

- The Gel Sizer may rupture during surgery, releasing gel into the surgical pocket. Causes of ruptures can include damage by surgical instruments, improper handling and manipulation.
- Forceps or hemostats should not be used.

DO NOT resterilize in packaging system provided.

DO NOT use the sizer until it has cooled completely.

DO NOT use alternate methods of sterilization or physical parameters.

DO NOT contact the Gel Sizer with disposable, capacitor-type cautery devices as damage to the shell of the Gel Sizer may result.

Careful hemostasis is important to prevent postoperative hematoma formation. Should excessive bleeding persist, it is recommended that the Sizer not be used until the bleeding is controlled.

This product is designed for temporary intraoperative insertion as a breast implant Sizer.

Preoperative evaluation of the eventual implant type and implant site with the Sizer should include allowances for adequate tissue coverage. Pressure, force, tension and other stresses to which the implant site will be susceptible must be considered.

PRECAUTIONS

Mentor recommends that the surgeon consider the size and firmness of the MemoryShape® Breast Implant to be implanted when choosing the optimum incision size and surgical approach. Certain surgical approaches may cause higher stresses on the sizer. The incision will be longer for MemoryShape® implants than the one typically made for round MemoryGel® Breast Implants. Reference the corresponding Mentor breast implant Product Insert Data Sheet (PIDS) for detailed warnings, precautions, implant selection and incision information.

Do not contact the Gel Sizer with disposable, capacitor-type cautery devices as damage to the shell of the Gel Sizer may result.

GENERAL ADVERSE EVENTS ASSOCIATED WITH USE OF SIZERS

Any patient undergoing a surgical procedure is subject to possible unforeseen operative and postoperative complications. Potential reactions and complications associated with the use of the Sizers and breast implant should be discussed with and understood by the patient prior to surgery. It is the responsibility of the surgeon, and Mentor relies on the surgeon, to provide the patient with this information and to weigh the risk/benefit for each patient.

Adverse reactions which may result from the use of the Sizers and corresponding breast implant include the risks associated with the medication and methods used in the surgical procedure as well as the patient's degree of tolerance to any foreign object placed in the body.

Potential adverse events that may occur with the use of the Sizers during breast implant surgery include: blood borne pathogen transmission/infection, failure of treatment or failure of aesthetic outcome (reoperation). Below is a description of these adverse events.

Blood Borne Pathogen Transmission/Infection

Blood borne pathogens, such as bacteria and viruses, are present in blood and body fluids and can be transmitted between users when improper handling or cleaning of sizers occurs. Signs of acute infection reported in association with breast implants include erythema, tenderness, fluid accumulation, pain, and fever. In rare instances, as with other invasive surgeries, Toxic Shock Syndrome (TSS) has been noted in women after breast implant surgery. It is a life-threatening condition. Symptoms of TSS occur suddenly and include a high fever (102°F, 38.8°C or higher), vomiting, diarrhea, a sunburn-like rash, red eyes, dizziness, lightheadedness, muscle aches, and drops in blood pressure, which may cause fainting. Patients should be instructed to contact a doctor immediately for diagnosis and treatment if they have these symptoms.

Failure of Treatment/Failure of Aesthetic Outcome (Reoperation)

Patients should be informed that dissatisfaction with cosmetic results related to such things as incorrect size, scar deformity, hypertrophic scarring, asymmetry, wrinkling, implant displacement/migration, and implant palpability/visibility might occur. Careful surgical planning or technique can minimize, but not

preclude, the risk of such results. Pre-existing asymmetry may not be entirely correctable. Revision surgery may be indicated to maintain patient satisfaction but carries additional considerations and risks.

HOW SUPPLIED

The Gel Sizer is supplied individually in a sterile and non-pyrogenic, double-thermoform packaging system. This product has been sterilized by Dry Heat Sterilization. Sterility cannot be guaranteed if the double-sealed packaging system has been damaged.

INSTRUCTIONS FOR USE

The Gel Sizer is provided sterile. Cleaning and sterilization is not necessary prior to first use.

The Gel Sizer must be cleaned and sterilized prior to each subsequent use. The Gel Sizer should not be resterilized more than nine (9) times.

Any surgeon performing breast augmentation or reconstruction with breast implants should be familiar with the currently available techniques for measuring the patient, determining the implant size and performing surgery.

The Gel Sizer is designed for temporary intraoperative insertion as a tool to assist the surgeon in determining the size and shape in permanent breast implant selection.

NOTE: It is advisable to have more than one size Gel Sizer in the operating room at the time of surgery to allow the surgeon flexibility in determining the appropriate size and shape of the breast implant to be used.

Lint, such as drape and sponge lint, dust, talc, surgical glove powder, fingerprints, skin oils and other surface contaminants deposited on the Gel Sizer by improper handling may cause foreign body reactions.

Strict adherence to clean, aseptic techniques should be maintained to prevent contamination of the device and possible complications. Surgical instruments and gloves should be rinsed clean of impurities before handling the Gel Sizer.

Each Gel Sizer should be checked for patency prior to use and continuously monitored throughout the procedure to ensure that the structural integrity of the device is not compromised in any way. This device should not be used following any modification to its original design. A Gel Sizer which has been damaged, or on which repairs or modifications have been attempted, should not be used.

The silicone elastomer shell may easily be cut by scalpel or ruptured by excessive stress, manipulation with blunt instruments or penetration by a needle. Forceps or hemostats should not be used.

Reprocessing Instructions

Warnings

Follow instructions and warnings as issued by the manufacturers of any decontaminants or cleaning agents. When handling soiled or contaminated medical devices, always handle with care, wearing protective clothing, gloves and eyewear in accordance with local Health and Safety procedures and OSHA Standard 29 CFR 1910.030, Occupational Exposure to Bloodborne Pathogens.

Limitations on Reprocessing

The Gel Sizer should not be sterilized more than nine (9) times.

After Initial Use

When the correct implant size is determined, remove the Gel Sizer from the mammary pocket.

For best results, reprocess immediately after use. Remove excess body fluids and tissue with a disposable, non-shedding wipe and cover device with a damp cloth.

Containment/Transportation

Devices should be placed in a basket or other containment device prior to transport to decontamination area.

Cleaning the Gel Sizer

For any reprocessing method to be effective, **the reusable device must be thoroughly cleaned before it is subjected to the sterilization process.** The following cleaning and sterilization techniques for Gel Sizers have been found effective for test devices and are provided as a guide:

1. Rinse soiled Gel Sizers under cold (approximately 68°F/20°C) tap water for a minimum of 3 minutes.
2. Soak Gel Sizers in a solution of alkaline, enzymatic or 1% anionic detergent for a minimum of 6 minutes. Water (type and temperature) used in the preparation of cleaning solutions should be in accordance with the manufacturer's recommendations.
3. Hand wash Gel Sizers for a minimum of 4 minutes, while submerged under the cleaning solution. Discard the cleaning solution after use.
4. Rinse Gel Sizers with warm (99-109°F/37-43°C) distilled water for a minimum of 3 minutes. Dry the cleaned device with a clean, lint-free towel or allow to air dry before packaging for sterilization.

Inspection

After cleaning, visually inspect the Gel Sizer for complete removal of soil or fluids. If any soil or fluid is still visible, repeat the previous cleaning steps.

Visually inspect and check all devices for damage.

Resterilizing the Gel Sizer

After cleaning the sizer, package the Gel Sizer in a suitable material intended for autoclave use (e.g., pack, sterilization wrapper, bag, or accessories); package loosely to allow expansion of the device during sterilization. Container systems should be permeable to allow steam penetration and direct contact with the device.

Place the packaged device in the autoclave, or on an open clean autoclaving tray if available, and autoclave with one of the following gravity-displacement methods:

- Displacement Cycle: **50 minutes at 250°F (121°C)** and 15 psi. Minimum dry time of 45 minutes is recommended.
- Optional Gravity-Displacement Cycle: **20 minutes at 270°F (132°C)** and 30 psi. Minimum dry time of 45 minutes is recommended.

The method of sterilization and the stated parameters outlined herein are the only method and parameters that have been qualified to deliver a sterile product while maintaining product integrity up to nine (9) times sterilization. **Do not use alternate methods of sterilization or physical parameters.**

Caution: Do not use a pre-vacuum high temperature autoclave cycle, immediate-use or “flash” sterilization autoclave cycle, ethylene oxide (EO), STERRAD® Sterilization System, or chemical sterilization methods. Do not dry the device using a vacuum cycle.

Standard operating protocol for autoclaving of reusable devices/instrumentation in individual healthcare facilities should be followed. Double wrapping/pouching of the Gel Sizer is an acceptable packaging configuration to facilitate sterile transfer of product into the surgical setting.

Immediate-use or “flash” sterilization cycles should not be used in accordance with AORN Recommended Practice IV for Sterilization in the Perioperative Practice Setting.

To dry the wrapped Gel Sizer after the autoclave cycle is complete, the autoclave door may be opened slightly to allow excess steam to escape, then closed while allowing the Gel Sizer to remain in the autoclave until the packaging material is entirely dry. Alternately, a programmed dry cycle of not less than 45 minutes may be used for a Gravity-Displacement Sterilization cycle. Also, air bubbles may appear in the gel following sterilization. These bubbles are expected and do not affect the integrity or purpose of the Gel Sizer.

The Gel Sizer may rupture while still hot from the autoclave and could require up to 45 minutes to cool based on sizer volume. Care must be used during handling to avoid damage while hot.

After each sterilization cycle, record the date of cleaning and sterilization and who performed the sterilization on the Sterilization Record card. The device and the card should be kept together to ensure keeping accurate sterilization records.

Because packaging methods and packaging materials may vary from one healthcare facility to another, Mentor cannot determine the shelf life for devices resterilized outside of our manufacturing facility. The shelf life of a packaged sterile item is event related. An event must occur to compromise package content sterility. For the selection and use of packaging systems, refer to a list of FDA-cleared packaging systems available and applicable healthcare standards and practices. Examples of standards and practices can be found with the Association for the Advancement of Medical Instrumentation (AAMI), the Association of periOperative Registered Nurses (AORN) and the Centers for Disease Control and Prevention—Healthcare Infection Control Practices Advisory Committees (CDC-HICPAC). Packaged devices should not be stacked and should be stored under environmentally controlled conditions for temperature and humidity. Provided the packaging

instructions are followed, the device will remain sterile to the date determined by individual policies and procedures for event-related sterility in perioperative settings.

The Gel Sizer can be sterilized up to nine (9) times, after which the device must be discarded.

Dispose of material in accordance with all federal, state, and local regulations. Responsibility for proper waste disposal is with the owner of the waste.

Sterility, safety and efficacy cannot be assured for damaged devices.

PRODUCT EVALUATION

Mentor requests that physicians notify the company of complications which occur with the use of this device. Any complications should be brought to the immediate attention of your local Mentor representative, who will be responsible for informing the Product Evaluation Department at Mentor, 3041 Skyway Circle North, Irving, TX 75038-3540.

RETURNED GOODS AUTHORIZATION

Authorization for return of merchandise should be obtained from your local Mentor representative prior to return of merchandise. Merchandise returned must have all manufacturer's seals intact.

PRODUCT INFORMATION DISCLAIMER

Mentor expressly disclaims all warranties, whether written or oral, statutory, express or implied by the operation of law or otherwise, including, but not limited to, any implied warranties of merchantability, fitness, or design. Mentor shall not be liable for any direct, incidental or consequential loss, damages or expense, indirectly arising from the use of this product. No representation or other affirmation of fact, including but not limited to statements regarding suitability for use, or performance of the product shall be or be deemed to be a warranty by Mentor for any purpose. Mentor neither assumes nor authorizes any other or additional liability or responsibility in connection with this device.

PRODUCT ORDER INFORMATION





















U.S. Customers

For product information or to order directly in the USA, please contact the Mentor Customer Service Department, 33 Technology Drive, Irvine, CA 92618. Toll-free telephone (800) 235-5731; FAX (805) 967-7108. Or visit www.MentorDirect.com.

SYMBOLS GLOSSARY

ISO 15223-1 Medical devices — Symbols to be used with medical device labels, labelling and information to be supplied

Title 21 Code of Federal Regulations Parts 801.109

	Low Height, Moderate Plus Profile		Not made with natural rubber latex		Non-pyrogenic ISO 15223-1 Reference 5.6.3
	Medium Height, Moderate Profile		Manufacturer ISO 15223-1 Reference 5.1.1		Sterilized using steam or dry heat ISO 15223-1 Reference 5.2.5
	Medium Height, High Profile		Date of manufacture ISO 15223-1 Reference 5.1.3		Consult instructions for use ISO 15223-1 Reference 5.4.3
	Medium Height, Moderate Plus Profile		Serial number ISO 15223-1 Reference 5.1.7		Caution ISO 15223-1 Reference 5.4.4
	Tall Height, Moderate Plus Profile		Catalogue number ISO 15223-1 Reference 5.1.6		Not returnable if opened
	Tall Height, High Profile		Batch code ISO 15223-1 Reference 5.1.5		CAUTION: Federal (USA) law restricts this device to sale by or on the order of a licensed healthcare practitioner. Title 21 Code of Federal Regulations Parts 801.109
	MemoryShape® Width, Height, Projection		Use-by date ISO 15223-1 Reference 5.1.4		

THIS PAGE IS LEFT BLANK INTENTIONALLY.

THIS PAGE IS LEFT BLANK INTENTIONALLY.

THIS PAGE IS LEFT BLANK INTENTIONALLY.

THIS PAGE IS LEFT BLANK INTENTIONALLY.

THIS PAGE IS LEFT BLANK INTENTIONALLY.

THIS PAGE IS LEFT BLANK INTENTIONALLY.

THIS PAGE IS LEFT BLANK INTENTIONALLY.

THIS PAGE IS LEFT BLANK INTENTIONALLY.

THIS PAGE IS LEFT BLANK INTENTIONALLY.

THIS PAGE IS LEFT BLANK INTENTIONALLY.

THIS PAGE IS LEFT BLANK INTENTIONALLY.

THIS PAGE IS LEFT BLANK INTENTIONALLY.

THIS PAGE IS LEFT BLANK INTENTIONALLY.

THIS PAGE IS LEFT BLANK INTENTIONALLY.

THIS PAGE IS LEFT BLANK INTENTIONALLY.

THIS PAGE IS LEFT BLANK INTENTIONALLY.

THIS PAGE IS LEFT BLANK INTENTIONALLY.

THIS PAGE IS LEFT BLANK INTENTIONALLY.

THIS PAGE IS LEFT BLANK INTENTIONALLY.

THIS PAGE IS LEFT BLANK INTENTIONALLY.

THIS PAGE IS LEFT BLANK INTENTIONALLY.

THIS PAGE IS LEFT BLANK INTENTIONALLY.

THIS PAGE IS LEFT BLANK INTENTIONALLY.

THIS PAGE IS LEFT BLANK INTENTIONALLY.

THIS PAGE IS LEFT BLANK INTENTIONALLY.

THIS PAGE IS LEFT BLANK INTENTIONALLY.

THIS PAGE IS LEFT BLANK INTENTIONALLY.

THIS PAGE IS LEFT BLANK INTENTIONALLY.

THIS PAGE IS LEFT BLANK INTENTIONALLY.

THIS PAGE IS LEFT BLANK INTENTIONALLY.

THIS PAGE IS LEFT BLANK INTENTIONALLY.

THIS PAGE IS LEFT BLANK INTENTIONALLY.

THIS PAGE IS LEFT BLANK INTENTIONALLY.

THIS PAGE IS LEFT BLANK INTENTIONALLY.

THIS PAGE IS LEFT BLANK INTENTIONALLY.

THIS PAGE IS LEFT BLANK INTENTIONALLY.

THIS PAGE IS LEFT BLANK INTENTIONALLY.

THIS PAGE IS LEFT BLANK INTENTIONALLY.

THIS PAGE IS LEFT BLANK INTENTIONALLY.

THIS PAGE IS LEFT BLANK INTENTIONALLY.

THIS PAGE IS LEFT BLANK INTENTIONALLY.

THIS PAGE IS LEFT BLANK INTENTIONALLY.

THIS PAGE IS LEFT BLANK INTENTIONALLY.

THIS PAGE IS LEFT BLANK INTENTIONALLY.

THIS PAGE IS LEFT BLANK INTENTIONALLY.

THIS PAGE IS LEFT BLANK INTENTIONALLY.

THIS PAGE IS LEFT BLANK INTENTIONALLY.

THIS PAGE IS LEFT BLANK INTENTIONALLY.

THIS PAGE IS LEFT BLANK INTENTIONALLY.

THIS PAGE IS LEFT BLANK INTENTIONALLY.

THIS PAGE IS LEFT BLANK INTENTIONALLY.



MENTOR[®]

For customer service, please call (800) 235-5731 in USA; or outside of USA,
call +1 (805) 879-6000, or contact your local representative.

www.mentorwwllc.com • www.mentordirect.com



Manufacturer

MENTOR

3041 Skyway Circle North

Irving, TX 75038-3540

USA

972-252-6060

© Mentor Worldwide, LLC 2015

IFU PRINTING SPECIFICATION SHEET

PAGE LAYOUT

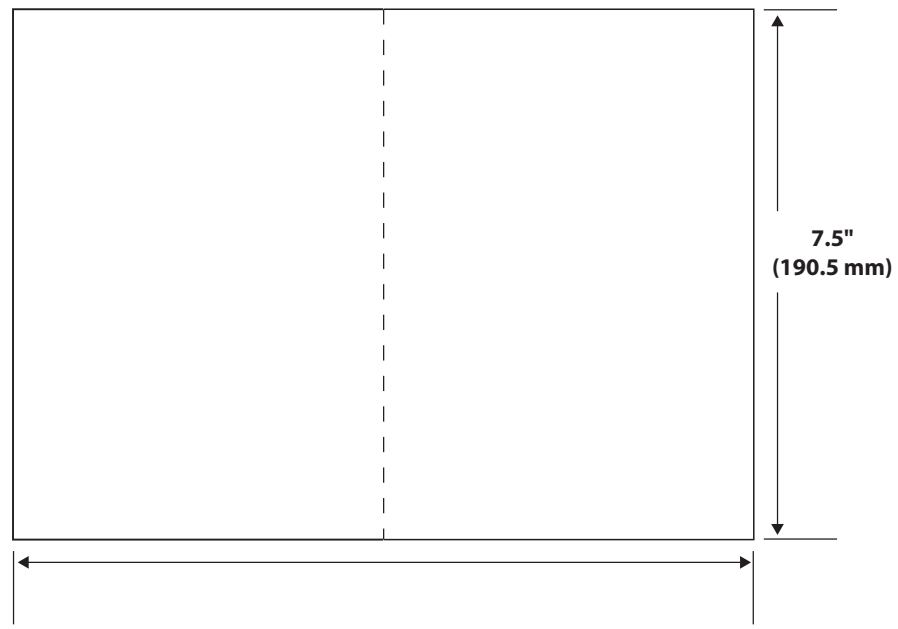

Flat Size
12.5" (317.5 mm)

FOLD PATTERN

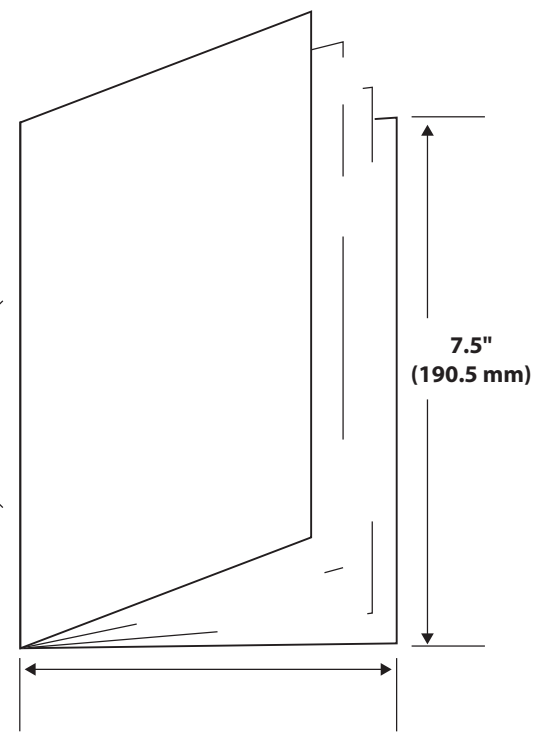

Folded Size
6.25" (158.75 mm)

Binding Method:
Saddle Stitch

TITLE MENTOR® Resterilizable Gel Breast Implant Sizer		DESCRIPTION Non CE PIDS		LAB NUMBER LAB100300459v2		SPECIAL INSTRUCTIONS/COMMENTS NA		BINDING Saddle Stitch		COLORS Black		
FLAT SIZE 12.5" x 7.5" 317.5 mm x 190.5 mm		FOLDED SIZE 6.25" x 7.5" 158.75 mm x 190.5 mm		RMC NUMBER 112009-001 Rev A	PAGE COUNT 60	LANGUAGES EN			SELF COVER <input checked="" type="checkbox"/>	PLUS COVER <input type="checkbox"/>	SEALING METHOD NA	WAFER SEAL <input type="checkbox"/>
BLEED SIZE .5" (12.7 mm) <input type="checkbox"/> .125" (3.175 mm) <input checked="" type="checkbox"/>		NONE <input type="checkbox"/>	BLEED ALL SIDES <input type="checkbox"/>	BLEED TOP <input type="checkbox"/>	BLEED RIGHT <input checked="" type="checkbox"/>	BLEED LEFT <input type="checkbox"/>	BLEED BOTTOM <input type="checkbox"/>	DRAWING IS NOT TO SCALE: DRAWINGS REFLECT INFORMATION FOR PRODUCTION OF PRINTED PIECES AND DO NOT CONTAIN ACTUAL ARTWORK. This document or data herein or herewith is not to be reproduced, used or disclosed in whole or part without the permission of Ethicon, Inc.				
STOCK 50 lb. White Offset						ETHICON						