

Patient Educational Brochure

AUGMENTATION

Breast Augmentation with
MENTOR® MemoryGel™ and MENTOR® MemoryGel™ Xtra
Silicone Gel Breast Implants



PATIENT EDUCATIONAL BROCHURE

AUGMENTATION

**BREAST AUGMENTATION WITH
MENTOR® MEMORYGEL™ AND MENTOR® MEMORYGEL™ XTRA
SILICONE GEL BREAST IMPLANTS**



TABLE OF CONTENTS

GLOSSARY	3
1. HOW TO USE THIS EDUCATIONAL BROCHURE	10
2. GENERAL INFORMATION ABOUT BREAST AUGMENTATION WITH BREAST IMPLANTS	10
2.1 What Gives the Breast Its Shape?	10
2.2 What Is a Silicone Gel Breast Implant?	10
2.3 How Do Breast Implants Work in Breast Augmentation?	11
3. DECIDING WHETHER TO HAVE BREAST AUGMENTATION SURGERY WITH IMPLANTS	11
3.1 Am I Eligible for Augmentation with Silicone Gel Breast Implants?	11
3.2 Contraindications	11
3.3 Precautions	11
3.4 Warnings	12
3.5 What Are the Alternatives to Implantation with Silicone Gel Breast Implants?	13
4. RISKS ASSOCIATED WITH BREAST IMPLANTS	13
4.1 What Are the Potential Complications?	18
4.2 What Are Other Reported Conditions?	24
5. BENEFITS ASSOCIATED WITH BREAST IMPLANTS	28
6. PREPARING FOR BREAST AUGMENTATION WITH SILICONE GEL BREAST IMPLANTS	28
6.1 Should I Have Breast Augmentation?	28
6.2 Breast Augmentation with Implants – Understanding the Procedure	29
6.3 Choosing the Right Implant for You	30
6.4 Other Procedures at the Time of the Breast Augmentation	32
6.5 Choosing a Surgeon	32
7. CARING FOR YOURSELF AFTER BREAST IMPLANT SURGERY	32
7.1 Postoperative Care in the Hours and Days After Surgery	32
7.2 Postoperative Care in the First Weeks After Surgery	33
7.3 Caring for Yourself in the Months and Years After Surgery	33
7.4 Monitoring Your Implants for Rupture	34
8. MENTOR'S CLINICAL STUDY RESULTS	35
8.1 Overview of the Study	35
8.2 What Are the 6-Year Follow-up Rates?	36
8.3 What Are the Benefits?	36
8.4 What Were the 6-Year Complication Rates?	37
8.5 What Are the Main Reasons for Reoperation?	38
8.6 What Are the Main Reasons for Implant Removal?	40
8.7 What Are Other Clinical Data Findings?	43
9. WHAT TO DO IF YOU HAVE A PROBLEM	45
10. WHERE TO FIND MORE INFORMATION	45
11. MENTOR'S IMPLANT TRACKING PROGRAM	46
11.1 Breast Implant Tracking	46
11.2 Device Identification Card	46
12. IMPORTANT CONTACT INFORMATION	47
13. WARRANTY INFORMATION	47
14. ACKNOWLEDGMENT OF INFORMED DECISION	49
15. INDEX	53
16. REFERENCES	55

GLOSSARY

Abdomen	The part of the body between the upper chest (breasts) and the pelvis (hips); often called the stomach.
Anaplastic Large Cell Lymphoma (ALCL)	ALCL is not breast cancer; it is a rare type of non-Hodgkin's lymphoma (cancer of the immune system).
Areola	The pigmented or darker colored area of skin surrounding the nipple.
Asymmetry	Uneven appearance between a woman's left and right breasts in terms of their size, shape or breast level.
Atrophy	Thinning or diminishing of tissue or muscle.
Autoimmune Disease	An autoimmune disease is a disease in which the body's immune system attacks its own cells or tissues by mistake, causing damage and dysfunction. Autoimmune diseases can affect connective tissue in the body (the tissue that binds together body tissues and organs). Autoimmune diseases can affect many parts of the body, like nerves, muscles, glands and the digestive system.
Axillary	Under the arm.
Biocompatible	The ability to exist along with living tissues or systems without causing harm.
Biopsy	The removal and examination of tissue, cells, or fluid from a living body.
Body Dysmorphic Disorder (BDD)	A psychological condition characterized by excessive worry about an imagined or minor physical flaw to the point that it can interfere with normal daily activities.
Body Esteem Scale	A series of questions asking about a person's feelings about his or her body.
Breast Augmentation	A surgical procedure to increase breast size and to treat such conditions as sagging or drooping of the breast (ptosis) or breasts of different size, shape, or placement (asymmetry). The first time a breast implant is placed to increase breast size or treat such conditions as ptosis or asymmetry, it is referred to as "primary augmentation." Any time there is another surgery to replace the implant, it is referred to as "revision-augmentation."
Breast Evaluation	A series of questions that ask about a person's breast.

Breast Implant	Any surgically implanted artificial device intended to replace missing breast tissue or to enhance a breast.
Breast Mass	A lump in the breast.
Breast Reconstruction	<p>A surgical procedure to replace breast tissue or reconstruct a breast after tissue was taken out because of cancer or injury. Breast reconstruction also includes the surgical correction of a breast that has failed to develop properly due to a severe abnormality or congenital defect.</p> <p>The first time a breast implant is placed to replace breast tissue is referred to as “primary reconstruction.” Any time there is another surgery to replace the implant, it is referred to as “revision-reconstruction.”</p>
Calcification/ Calcium Deposits	The process of soft tissue hardening when the mineral calcium builds up in a certain place.
Capsular Contracture	Tightening of the scar tissue (also called a capsule) that normally forms around the breast implant during the healing process after surgery. In some women, the scar tissue (capsule) squeezes the implant. When this occurs, it is called capsular contracture. This results in firmness or hardening of the breast. Capsular contracture is classified by the Baker Grade Scale.
Capsule	Scar tissue that forms around the breast implant.
Capsulotomy (Closed)	An attempt to break the scar tissue capsule around the implant by pressing or pushing on the outside of the breast. This method does not require surgery but may rupture the implant and is contraindicated (meaning that the procedure is improper and should not be performed).
Capsulotomy (Open)	A surgery to create an incision or opening in the capsule (scar tissue).
Chest Wall	The system of structures outside the lungs that move as a part of breathing, including bones (the rib cage) and muscles (diaphragm and abdomen).
Congenital Anomaly	An abnormal body part that existed at birth. Also called a congenital malformation or congenital deformity.
Connective Tissue Disease/Disorder (CTD)	A disease, group of diseases, or conditions affecting connective tissue, such as muscles, ligaments, skin, etc. and/or the immune system. Connective tissue diseases (“CTDs”) that involve the immune system include autoimmune diseases such as rheumatoid arthritis, lupus, and scleroderma.

Contraindication	A use that is improper and should not be followed. Failure to follow contraindications identified in the labeling could cause serious harm.
Delayed Wound Healing	Unusually slow progress in the healing of a wound; surgical incision site fails to heal normally or takes longer to heal.
Displacement	Movement (shifting) of the implant from the usual or proper place.
Extracapsular Rupture	A type of rupture in which the silicone gel is outside of the scar capsule surrounding the breast implant (see Rupture).
Extrusion	Skin breakdown with the implant pressing through the skin or surgical incision.
Fibrocystic Breast Disease	Common, benign (noncancerous) changes in the tissues of the breast. The term “disease” is misleading, and many doctors prefer the term “change.” The condition is so commonly found in breasts, it is believed to be a variation of normal. Other related terms include “mammary dysplasia,” “benign breast disease,” and “diffuse cystic mastopathy.”
Fibromyalgia	A chronic condition characterized by widespread pain in muscles and joints. It may include fatigue, difficulty sleeping, and morning stiffness.
Fibrous Tissues	Connective tissue composed mostly of fibers (for example, tendons).
Gel Bleed/Gel Diffusion	When silicone gel leaks or “bleeds” or “diffuses” through the implant shell.
Granuloma	Noncancerous lumps that can form around foreign material, such as silicone. Like any lump, it should be evaluated to distinguish it from a lump that might be cancerous.
Groin	The fold where the lower abdomen meets the inner part of the thigh.
Hematoma	A collection of blood inside the body, for example in skin tissue or other body space.
Hypertrophic Scarring	An enlarged scar that remains after a wound heals.
Infection	The growth in the human body of microorganisms such as bacteria, viruses or fungi. An infection can occur as a result of any surgery.

Inflammation/Irritation	The response of the body to infection or injury resulting in swelling, redness, warmth and/or pain.
Inframammary Fold	The crease under the breast where the breast and chest meet.
Inframammary Incision	An incision made in the fold below the breast.
Intracapsular Rupture	A type of rupture in which the silicone gel remains inside the scar tissue capsule surrounding the breast implant (see Rupture).
Lactation	The production and secretion of milk by the breast glands.
Local Complications	Complications that occur in the breast or chest area.
Lymph Nodes	Lymph nodes are glands that play an important part in the body's defense against infection. They produce lymph, which travels throughout the body in the lymph system, and filters impurities from the body. Common areas where the lymph nodes can be felt with the fingers include: groin, armpit, neck, under the jaw and chin, behind the ears, and on the back of the head.
Lymphadenopathy	Enlarged lymph node(s).
Malposition	When the implant is placed incorrectly during the initial surgery or when the implant has moved/shifted from its original position. Shifting can be caused by many factors, such as gravity, trauma, poor initial placement, and capsular contracture.
Mammary	Pertaining to the breast.
Mammography	A type of x-ray examination of the breasts used for detection of cancer.
Mammoplasty	Plastic surgery of the breast.
Mastopexy	Surgical procedure to raise and reshape sagging breasts.
MemoryGel™ Breast Implant Core Study	A Core study is the clinical study that supports the approval of a medical product (such as breast implants). For Mentor's breast implants, the MemoryGel™ Breast Implant Core Study includes augmentation, reconstruction, and revision (revision-augmentation and revision-reconstruction) patients. Information on the safety and effectiveness of the implants are collected every year for 10 years after study participants get their implants.

Migration/Gel Migration	Movement of silicone material outside the breast implant to other areas of the body.
MRI (Magnetic Resonance Imaging)	MRI uses a magnetic field to create a 3-dimensional picture of a body part or organ. MRI is the imaging method that currently has the best ability to detect rupture of silicone gel breast implants.
Necrosis	Death of cells or tissues.
Palpability/Visibility	Palpability is when the implant can be felt through the skin. Visibility is when the implant can be seen through the skin.
Pectoralis	Major muscle of the chest.
Periareolar	The areola is the pigmented or darker colored area of skin surrounding the nipple. Periareolar refers to the area just around the areola.
Periumbilical	Around the belly button.
Plastic Surgery	Surgery intended to enhance or improve the appearance of the body.
Platinum	A metallic element used to help make both silicone elastomer (the rubbery material of the breast implant shell) and silicone gel.
Postoperative	After surgery.
Precautions	Information that warns the reader of a potentially hazardous situation that, if not avoided, may result in minor or moderate injury.
Primary Breast Augmentation	The first time a breast implant is placed for the purpose of breast augmentation.
Prosthesis	Any artificial device used to replace or represent a body part.
Ptosis	Sagging or drooping of the breast.
Quality of Life (QoL) Measures	Assessments that may contribute to the evaluation of benefit (effectiveness), including the Rosenberg Self Esteem Scale (measures self-worth or self-acceptance), the Body Esteem Scale (measures a person's body image), and the SF-36 (measures physical, mental, and social health).
Redness/Bruising	Bleeding at the surgical site that causes discoloration and varies in degree and length of time. This is expected following breast implant surgery or other breast procedures.

Removal	Removal of the implant, with or without replacement using another implant.
Reoperation	Any additional surgery performed to the breast or chest area after the first breast implantation.
Revision-Augmentation	Refers to the correction or improvement of a primary augmentation. In the context of this document, it refers to surgical removal and replacement of breast implants that were placed originally for primary breast augmentation.
Rheumatological Disease/Disorder	A variety of diseases involving connective tissue structures of the body, especially the joints and fibrous tissue. These diseases are often associated with pain, inflammation, stiffness, and/or limitation of motion of the affected parts. Can include autoimmune diseases. Fibromyalgia is a rheumatological disorder.
Risks	The chance or likelihood that an undesirable effect will occur
Rosenberg Self-Esteem Scale	A questionnaire that measures overall self-esteem.
Rupture	A hole or tear in the shell of the implant that allows silicone gel filler material to leak from the shell.
Saline	Saltwater (a solution made of water and a small amount of salt).
Scar Revision	A surgical procedure to improve the appearance of a scar.
Scarring	Formation of tissue at an incision site; all wounds heal by the formation of a scar.
Seroma	Similar to a bruise, a seroma occurs when the watery portion of the blood collects around a surgical incision or around a breast implant.
SF-36 Scale	The Short Form 36 Health Scale; a questionnaire intended to measure physical, mental, and social health.
Silent Rupture	A breast implant rupture without symptoms or a visible change. Silent rupture cannot be felt by the woman or detected by a doctor through physical examination. Silent rupture can only be discovered through appropriate imaging techniques such as MRI.
Silicone	Silicone is a man-made material that can be found in several forms such as oil, gel, or rubber (elastomer). The exact make-up of silicone will be different depending on its use.

Silicone Elastomer	A type of silicone that has elastic properties similar to rubber.
Silicones – Low Molecular Weight (LMW)	Small silicone molecules that may be present in gel bleed/gel diffusion.
Subglandular Placement	When the implant is placed under and within the breast glands (breast tissue) but on top of the chest muscles.
Submuscular Placement	When the implant is placed underneath the chest muscles.
Surgical Incision	A cut made to body tissue during surgery.
Symptom	Any perceptible change in the body or its functions that indicates disease or a phase of a disease.
Symptomatic	Experiencing symptoms; any evidence or sign of disease or disorder.
Symptomatic Rupture	A breast implant rupture that is associated with symptoms (such as lumps, persistent pain, swelling, hardening, or change in implant shape).
Systemic	Pertaining to or affecting the body as a whole.
Tennessee Self Concept Scale (TSCS)	A questionnaire that evaluates how the patient sees herself and what she does, likes, and feels. The scale is intended to summarize an individual's feeling of self-worth, the degree to which the self-image is realistic, and whether or not that self-image is normal. It also measures the following aspects of how the patient feels about herself: moral-ethical, social, personal, physical, and family, identity, behavior, and self-satisfaction.
Toxic Shock Syndrome (TSS)	A rare, but life-threatening bacterial infection that may occur after surgery. Symptoms of TSS occur suddenly: a high fever, vomiting, diarrhea, a sunburn-like rash, red eyes, dizziness, lightheadedness, muscle aches, and/or drops in blood pressure, which may cause fainting. A doctor should be seen immediately for diagnosis and treatment if TSS is suspected.
Warnings	A statement that alerts the reader about a situation that, if not avoided, could result in serious injury or death.
Wound Dehiscence (Wound Opening)	Opening of a wound.
Wrinkling/Rippling	Wrinkling of the implant that can be felt or seen through the skin.

1. HOW TO USE THIS EDUCATIONAL BROCHURE

Mentor, the company that sells MemoryGel™ Breast Implants and MemoryGel™ Xtra Breast Implants, has designed this educational brochure to help you understand breast augmentation and to help you talk with your doctor(s) about breast augmentation. Mentor sponsored a large clinical study of these breast implants (also referred to in this brochure as the “MemoryGel™ Breast Implant Core Study”) that gathered data about these breast implants. There are 1,008 patients participating in the MemoryGel™ Breast Implant Core Study. A total of 552 patients had primary-augmentation, 145 patients had revision-augmentation, 251 patients had primary-reconstruction, and 60 patients had revision-reconstruction with MENTOR® MemoryGel™ Breast Implants. Results from this study are presented in Section 8 of this brochure.

After you receive this information, give yourself time to read and think about the information. Because breast implants will require monitoring and care for the rest of your life, you should wait 1-2 weeks after reviewing and considering this information before deciding whether to have the surgery. If you are having revision-augmentation surgery, your surgeon may advise you to have the surgery sooner.

If you decide to have the surgery, you will be asked to sign a statement before the surgery. The statement says you have read and understood the information in this brochure and that you have been informed of the benefits and risks of breast implants. This statement is called the “Acknowledgment of Informed Decision,” and there is a copy of it at the end of this brochure. Make sure all of your questions have been answered and you understand the information in this brochure, before you sign the “Acknowledgment of Informed Decision.”

2. GENERAL INFORMATION ABOUT BREAST AUGMENTATION WITH BREAST IMPLANTS

The information in this section provides some general information about breast augmentation with breast implants.

2.1 What Gives the Breast Its Shape?

As shown in Figure 1, your breast consists of milk ducts, glands, blood vessels, and nerves that are surrounded by fatty tissue. Glandular tissue is firm and gives the breast its shape. The fatty tissue gives the breast its soft feel. The chest muscle (the pectoralis major muscle) is located underneath all this breast tissue but does not have much effect on the shape or feel of the breast.

Figure 1.
Anatomy of the Breast

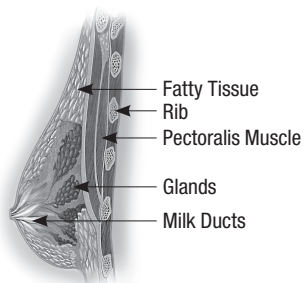

2.2 What Is a Silicone Gel Breast Implant?

A silicone gel breast implant is a sac (implant shell) made of silicone elastomer (rubber), which is filled with clear silicone gel. Mentor uses medical grade silicone elastomer and gel to manufacture its breast implants. Mentor’s silicone gel breast implants are designed to resemble the human breast in shape, weight, and feel.

MENTOR® MemoryGel™ Breast Implants and MENTOR® MemoryGel™ Xtra Breast Implants are round devices with shells constructed from medical grade silicone elastomer. The shell is filled with MemoryGel™, Mentor’s proprietary formulation of medical grade silicone gel, and is constructed of successive cross-linked layers of silicone elastomer. There are two styles of shell: smooth and textured. In general, MENTOR® MemoryGel™ Xtra Breast Implants have a higher fill than MENTOR® MemoryGel™ Breast Implants. More information on the types of MemoryGel™ and MemoryGel™ Xtra Breast Implants can be found in Section 6.3 (*Choosing the Right Implant for You*).

2.3 How Do Breast Implants Work in Breast Augmentation?

Breast implants are used to make the breasts larger or to restore or replace breast tissue. They are surgically implanted beneath your breast tissue, either on top of the chest muscle (subglandular placement) or underneath part or all of the chest muscle (submuscular placement).

3. DECIDING WHETHER TO HAVE BREAST AUGMENTATION SURGERY WITH IMPLANTS

The answers to the questions in this section will help you to decide whether breast augmentation surgery with implants is right for you.

3.1 Am I Eligible for Augmentation with Silicone Gel Breast Implants?

Breast implants have been approved for use in augmentation in two cases:

- **Primary augmentation** to increase the size and proportions of the breast(s) in women at least 22 years old.
- **Revision-augmentation** to correct or improve the result of primary augmentation. Revision-augmentation includes replacing an existing breast implant.

Women who have lost breast tissue to cancer or injury or want to correct a congenital anomaly may also use MemoryGel™ Breast Implants or MemoryGel™ Xtra Breast Implants. This is considered breast reconstruction with implants.

A different educational brochure that describes breast reconstruction with MemoryGel™ Breast Implants or MemoryGel™ Xtra Breast Implants is available for you to read if appropriate to your situation.

3.2 Contraindications

A contraindication is a condition or circumstance that, if present, means a procedure should not be done. Contraindications for breast implant surgery are discussed in this section.

MemoryGel™ Breast Implants and MemoryGel™ Xtra Breast Implants are contraindicated in the following circumstances because the risk of undergoing breast augmentation with implants outweighs the benefits:

- Women with active infection anywhere in their bodies,
- Women with existing cancer or pre-cancer of their breast who have not received adequate treatment for those conditions, and in
- Women who are pregnant or nursing.

Surgery in general is not recommended in patients with an active infection, existing cancer or pre-cancer and existing pregnancy (unless the surgery is to treat the infection, cancer or pregnancy as recommended by your doctor), as it may interfere with the treatment of the infection or the cancer and safety of the pregnancy/nursing. In addition, these conditions may interfere with the healing after surgery.

Adequate studies have not been performed to demonstrate the safety of breast implant surgery in women with these conditions or under these circumstances; therefore, if you have any of the above conditions or circumstances, breast augmentation surgery with implants should not be performed at this time. Failure to take into consideration these contraindications may increase the risks involved with the surgery and could cause harm.

3.3 Precautions

CAUTION: Notify your doctor if you have any of the following conditions as the risks of breast implant surgery may be higher if you have any of these conditions.

- An autoimmune disease
- A weakened immune system (for example, currently taking drugs that weaken the body's natural resistance to disease)
- Planned chemotherapy following breast implant placement

- Planned radiation therapy to the breast following breast implant placement
- Conditions that interfere with wound healing and/or blood clotting
- Reduced blood supply to breast tissue
- Clinical diagnosis of depression or other mental health disorders, including body dysmorphic disorder and eating disorders. If you have been diagnosed with or treated for depression, an anxiety disorder, or another mental health condition, you should wait until your condition has resolved or stabilized before having breast implant surgery. Discuss any history of mental health disorders with your doctor(s) prior to surgery.

Before you have surgery, you should have a detailed conversation with all of your doctors (primary care doctor, surgeon, and any specialists you see) about breast implant surgery in light of your medical history.

CAUTION: In order to avoid possible injury or damage to your incision site(s), you should avoid the following for the first month after your surgery:

- Sun exposure,
- Jerky movements or activities that stretch the skin at your incision site(s),
- Participating in sports or other activities that raise your pulse or blood pressure, and
- Unnecessary physical or emotional stress.

3.4 Warnings

Read this entire brochure before having breast implant surgery so that you will understand the risks and benefits and have realistic expectations of the outcome of your surgery. Breast implants are associated with many short-term and long-term risks.

WARNING – Smoking can make it harder for your body to heal. If you smoke, your doctor will probably have told you to stop before your surgery. Do not smoke while you are recovering from breast implant surgery.

WARNING – The following is a list of possible complications associated with breast implant surgery. Make sure you read and understand these before deciding whether to have breast implant surgery. Please refer to the following sections in this brochure for more detail on these factors: Section 4 - *RISKS ASSOCIATED WITH BREAST IMPLANTS*, Section 7 - *CARING FOR YOURSELF AFTER BREAST IMPLANT SURGERY* and Section 8 - *MENTOR'S CLINICAL STUDY RESULTS*.

- Breast implants are not expected to last for the rest of your life, and breast implantation may not be a one-time surgery. It is likely that you will need other surgery related to your breast implants over the course of your life. These additional surgeries can include implant removal with or without replacement, or they can include other surgical procedures.
- Many of the changes to your breast that may occur as a result of breast implant surgery will be permanent and cannot be undone. If you have your implants removed, your skin may be permanently dimpled, puckered, or wrinkled.
- Breast implants may interfere with your ability to produce milk (lactate) for breastfeeding. If you are planning to breastfeed your infant, be prepared to use formula and bottle-feed your baby in the event you have difficulty breastfeeding.
- Mammography for detecting breast cancer (or cancer recurrence) may be more difficult with breast implants in place. You will need more views captured than during a routine mammogram. Therefore, the procedure will take more time and you will be exposed to more radiation than during a standard routine screening mammogram. However, the benefits of mammograms outweigh this risk. You must tell the technologist that you have silicone gel breast implants before the procedure. The technologist can then use special techniques to get the best possible views of your breast tissue.

- Your implants could rupture without you feeling the rupture or noticing any change in your breasts. In some of these instances even your doctor might not be able to tell that a rupture has occurred. A rupture that has no symptoms is called a “silent” rupture. The best way to diagnose a silent rupture is with an MRI examination. An MRI is similar to using x-ray imaging but an MRI machine uses magnetism and not x-ray radiation. Because silent ruptures can occur and because they are difficult to detect, you should have an MRI 3 years after your breast implant surgery and then every 2 years after that for as long as you have your breast implants.
- Routine self-examination of your breasts may be more difficult with implants. However, you should still perform an examination of your breasts every month for cancer screening. Ask your surgeon to help you distinguish the implant from your breast tissue. You should perform an examination of your breasts for the presence of lumps, swelling, hardening, or change in implant shape, which may be signs of rupture of the implant. Report any of these symptoms or persistent pain to your doctor. Your surgeon may recommend an evaluation via MRI to check for rupture.
- After undergoing breast augmentation surgery, you may experience changes in your healthcare insurance. Your health insurance premiums may increase; your coverage may be dropped or discontinued; you may not be able to get health insurance coverage in the future; and/or insurance may not cover treatment of complications associated with your breast implants. Be sure to check with your insurance company about these potential issues and understand the complete extent of your health coverage before having breast augmentation with implants.
- Capsular contracture is not to be treated by closed capsulotomy or forceful external compression, which will likely result in implant damage, rupture, folds, and/or hematoma.

3.5 What Are the Alternatives to Implantation with Silicone Gel Breast Implants?

If this is your first (primary) breast augmentation surgery your alternatives may include:

- Electing to have no surgery,
- Wearing a padded bra or external prosthesis,
- Having a breast lift surgery (mastopexy) without implant(s),
- Having breast augmentation with saline-filled implants, or
- Having fat injection(s).

If you are considering a revision surgery, your alternatives may include:

- No revision surgery,
- Removing your implants without replacing them,
- Wearing a padded bra or external prosthesis,
- Having revision breast augmentation with saline-filled implants, or
- Having fat injection(s).

4. RISKS ASSOCIATED WITH BREAST IMPLANTS

Undergoing any type of surgery involves risks. There are a number of local complications (problems at or near the breast/surgical incision site) that may occur after you have silicone gel breast implant surgery. The following addresses both general, surgery-related complications and implant-related complications.

Tables 1 and 2 below present the potential risks associated with breast implant surgery, the likelihood of the risks based on the results from Mentor’s MemoryGel™ Breast Implant Core Study through 6 years, as well as the possible effects of the events for primary and revision-augmentation patients.

Table 1.
Potential Risks Associated with Primary Breast Augmentation

Event	Likelihood of the Event Occurring¹ Through 6 Years	Possible Resulting Effects of the Event
Key Complications		
Capsular Contracture Baker Grade III/IV	10 out of 100 patients (10%)	<ul style="list-style-type: none"> • Pain or discomfort • Breast hardness/firmness • Reoperation • Implant removal
Infection	2 out of 100 patients (2%)	<ul style="list-style-type: none"> • Redness or rash • Pain or tenderness • Swelling • Fever • Reoperation • Implant removal
Implant Removal with or without Replacement	7 out of 100 patients (7%)	<ul style="list-style-type: none"> • Infection • Scarring
Implant Removal with Replacement with Study Device	4 out of 100 patients (4%)	<ul style="list-style-type: none"> • Hematoma or Seroma • Delayed wound healing • Necrosis
Any Reoperation	19 out of 100 patients (19%)	<ul style="list-style-type: none"> • Pain or Discomfort • Anesthesia-related complications • Loss of breast tissue • Undesirable cosmetic result
Implant Rupture ²	3 out of 100 patients (3%)	<ul style="list-style-type: none"> • Implant removal
Other Complications \geq 1%		
Nipple Sensation Changes ³	12 out of 100 patients (12%)	<ul style="list-style-type: none"> • Increased or decreased nipple sensitivity • Breastfeeding difficulties • May affect sexual response
Hypertrophic Scarring (irregular, raised scar)	7 out of 100 patients (7%)	<ul style="list-style-type: none"> • Scar revision procedure (reoperation) • Undesirable cosmetic result
Ptosis (sagging)	6 out of 100 patients (6%)	<ul style="list-style-type: none"> • Undesirable cosmetic result • Wrinkling/Rippling • Reoperation • Implant removal
Breast Mass	5 out of 100 patients (5%)	<ul style="list-style-type: none"> • Pain or discomfort • Reoperation or other procedures
Miscarriage	3 out of 100 patients (3%)	<ul style="list-style-type: none"> • Pain or discomfort

Table 1. *Continued on next page*

Table 1. (Continued)

Event	Likelihood of the Event Occurring¹ Through 6 Years	Possible Resulting Effects of the Event
Other Complications \geq 1%		
Hematoma	3 out of 100 patients (3%)	<ul style="list-style-type: none"> • Swelling and bruising • Pain or discomfort • Infection • Incision and drainage (reoperation) • Implant removal
Breast Sensation Changes ³	3 out of 100 patients (3%)	<ul style="list-style-type: none"> • Increased or decreased breast sensitivity
Breast Pain ³	2 out of 100 patients (2%)	<ul style="list-style-type: none"> • Resulting effects are contingent on underlying cause(s)
Lactation Difficulties	2 out of 100 patients (2%)	<ul style="list-style-type: none"> • Painful breastfeeding • Inability to successfully breastfeed
Capsular Contracture Baker Grade II with Surgical Intervention	2 out of 100 patients (2%)	<ul style="list-style-type: none"> • Pain or discomfort • Breast hardness/firmness • Reoperation • Implant removal
New Diagnosis of Rheumatic Disease	1 out of 100 patients (1%)	<ul style="list-style-type: none"> • Pain or discomfort
Seroma	1 out of 100 patients (1%)	<ul style="list-style-type: none"> • Swelling and bruising • Pain or discomfort • Infection • Incision and drainage (reoperation) • Implant removal
Wrinkling ³	1 out of 100 patients (1%)	<ul style="list-style-type: none"> • Discomfort • Undesirable cosmetic result • Reoperation • Implant removal

¹Based on the results of the MENTOR® MemoryGel™ Breast Implant Core Study.

²MRI cohort; MRI screening for silent rupture is scheduled at 1, 2, 4, and 6 years (results provided in Table 10).

³Mild occurrences not included.

Table 2.
Potential Risks Associated with Revision-Augmentation

Event	Likelihood of the Event Occurring ¹ Through 6 Years	Possible Resulting Effects of the Event
Key Complications		
Capsular Contracture Baker Grade III/IV	22 out of 100 patients (22%)	<ul style="list-style-type: none"> • Pain or discomfort • Breast hardness/firmness • Reoperation • Implant removal
Infection	1 out of 100 patients (1%)	<ul style="list-style-type: none"> • Redness or rash • Pain or tenderness • Swelling • Fever • Reoperation • Implant removal
Implant Removal with or without Replacement	18 out of 100 patients (18%)	<ul style="list-style-type: none"> • Infection • Scarring
Implant Removal with Replacement with Study Device	9 out of 100 patients (9%)	<ul style="list-style-type: none"> • Hematoma or Seroma • Delayed wound healing • Necrosis
Any Reoperation	33 out of 100 patients (33%)	<ul style="list-style-type: none"> • Pain or Discomfort • Anesthesia-related complications • Loss of breast tissue • Undesirable cosmetic result
Implant Rupture ²	7 out of 100 patients (7%)	<ul style="list-style-type: none"> • Implant removal
Other Complications $\geq 1\%$		
Nipple Sensation Changes ³	13 out of 100 patients (13%)	<ul style="list-style-type: none"> • Increased or decreased nipple sensitivity • Breastfeeding difficulties • May affect sexual response
Hypertrophic Scarring (irregular raised scar)	8 out of 100 patients (8%)	<ul style="list-style-type: none"> • Scar revision procedure (reoperation) • Undesirable cosmetic result
Breast Mass	6 out of 100 patients (6%)	<ul style="list-style-type: none"> • Pain or discomfort • Reoperation or other procedures
Capsular Contracture Baker Grade II with Surgical Intervention	5 out of 100 patients (5%)	<ul style="list-style-type: none"> • Pain or discomfort • Breast hardness/firmness • Reoperation • Implant removal
Hematoma	3 out of 100 patients (3%)	<ul style="list-style-type: none"> • Swelling and bruising • Pain or discomfort • Infection • Incision and drainage (reoperation) • Implant removal
Miscarriage	2 out of 100 patients (2%)	<ul style="list-style-type: none"> • Pain or discomfort

Table 2. Continued on next page

Table 2. (Continued)

Event	Likelihood of the Event Occurring ¹ Through 6 Years	Possible Resulting Effects of the Event
Other Complications $\geq 1\%$		
Granuloma	2 out of 100 patients (2%)	<ul style="list-style-type: none"> • Pain or discomfort • Reoperation or other procedures
Delayed Wound Healing ³	2 out of 100 patients (2%)	<ul style="list-style-type: none"> • Pain or discomfort • Scarring • Implant extrusion • Necrosis • Reoperation • Implant removal
Seroma	2 out of 100 patients (2%)	<ul style="list-style-type: none"> • Swelling and bruising • Pain or discomfort • Infection • Incision and drainage (reoperation) • Implant removal
New Diagnosis of Breast Cancer	2 out of 100 patients (2%)	<ul style="list-style-type: none"> • Reoperation or other procedures
New Diagnosis of Rheumatic Disease	2 out of 100 patients (2%)	<ul style="list-style-type: none"> • Pain or discomfort
Lactation Difficulties	2 out of 100 patients (2%)	<ul style="list-style-type: none"> • Painful breastfeeding • Inability to successfully breastfeed
Ptosis (sagging)	2 out of 100 patients (2%)	<ul style="list-style-type: none"> • Undesirable cosmetic result • Wrinkling/Rippling • Reoperation • Implant removal
Wrinkling ³	2 out of 100 patients (2%)	<ul style="list-style-type: none"> • Discomfort • Undesirable cosmetic result • Reoperation • Implant removal
Breast Pain ³	1 out of 100 patients (1%)	<ul style="list-style-type: none"> • Resulting effects are contingent on underlying cause(s)
Extrusion	1 out of 100 patients (1%)	<ul style="list-style-type: none"> • Pain or discomfort • Scarring • Reoperation • Implant removal
Inflammation of Breast	1 out of 100 patients (1%)	<ul style="list-style-type: none"> • Resulting effects are contingent on underlying cause(s)

Table 2. Continued on next page

Table 2. (Continued)

Event	Likelihood of the Event Occurring ¹ Through 6 Years	Possible Resulting Effects of the Event
Other Complications $\geq 1\%$		
Implant Malposition/ Displacement	1 out of 100 patients (1%)	<ul style="list-style-type: none"> • Undesirable cosmetic result • Asymmetry • Visibility • Reoperation • Implant removal
Breast Sensation Changes ³	1 out of 100 patients (1%)	<ul style="list-style-type: none"> • Increased or decreased breast sensitivity

¹Based on the results of the MENTOR® MemoryGel™ Breast Implant Core Study.

²MRI cohort; MRI screening for silent rupture is scheduled at 1, 2, 4, and 6 years (results provided in Table 10).

³Mild occurrences not included.

Using information from Mentor's MemoryGel™ Breast Implant Core Study, the risk of a patient experiencing any complication (excluding rupture) at some point through 6 years after implant surgery was calculated. Through 6 years, this risk was 44% for primary augmentation patients and 54% for revision-augmentation patients. This means that 44 out of 100 primary augmentation patients and 54 out of 100 revision-augmentation patients may experience a complication (of some kind) within 6 years after receiving implants. For additional information on events reported in the MemoryGel™ Breast Implant Core Study, please read the section of this brochure on the MemoryGel™ Breast Implant Core Study (Section 8).

Mentor will continue its MemoryGel™ Breast Implant Core Study through the end of each patient's 10-year study term. In addition, Mentor has a post-approval study to address long-term outcomes in patients with MemoryGel™ Breast Implants. Mentor will update its product labeling on a regular basis with the results of these studies.

4.1 What Are the Potential Complications?

• Infection

Infection is a possible consequence of any kind of surgery. It most often happens within days to weeks after the surgery, but you could develop an infection in your breast(s) at any time. Breast and nipple piercing procedures may increase the possibility of infection. Signs that you have an infection include: redness or rash, tenderness or pain, fluid accumulation in or around the breast(s), and fever. If you experience any of these symptoms, call your doctor right away. It is harder to treat an infection with an implant present. If antibiotics do not cure your infection, it is possible that your implant(s) may have to be removed to treat the infection.

In rare cases, Toxic Shock Syndrome (TSS) has been noted in women after surgery, including breast implant surgery. TSS is a life-threatening condition. Symptoms of TSS occur suddenly: a high fever, vomiting, diarrhea, a sunburn-like rash, red eyes, dizziness, lightheadedness, muscle aches, and/or drops in blood pressure, which may cause fainting. If you feel any of these symptoms, contact a doctor immediately.

• Hematoma or Seroma

You may experience a hematoma or a seroma following your surgery. A hematoma is similar to a bruise; hematomas related to breast implants are the collection of blood within the space around the implant. A seroma is a buildup of fluid around the implant.

Symptoms from a hematoma or seroma may include swelling, pain, and bruising. Having a hematoma and/or seroma following surgery may result in infection and/or capsular contracture later on. If a hematoma or seroma occurs, it will usually be soon after surgery. However, other injuries to the breast can cause hematomas and/or seromas in your breast.

The body can absorb small hematomas and seromas on its own, but some will require surgery. When surgery is needed, it often involves draining the blood or fluid and sometimes involves placing a surgical drain in the wound temporarily for proper healing. A small scar can result from surgical draining. Implants may rupture if they are damaged by surgical instruments during the draining procedure.

• Capsular Contracture

After your breast implant surgery, your breasts will begin to heal and to adapt to the presence of the breast implants. A regular part of this process is that the breast tissue typically forms an internal scar immediately surrounding the implant. In many cases, this tissue forms a capsule that helps hold the implant in place. However, in some women, the scar tissue around the implant tightens and squeezes the implant. When scar tissue squeezes an implant, it is called capsular contracture.

Capsular contracture causes the breast to feel abnormally firm or hard and can cause pain. There is a scale for describing the severity of the contracture. It is called the Baker Grading Scale. The grades are:

- Grade I – contracture is observed, but the breast feels and looks normal (it is soft)
- Grade II – the breast is a little firm, but looks normal
- Grade III – the breast is firm and looks abnormal
- Grade IV – the breast is hard, painful, and looks abnormal

Capsular contracture may be more common if you have had a breast infection or hematoma/seroma. The chances of having contracture typically increase the longer you have your implants. Capsular contracture is a risk factor for implant rupture,⁹ and it is one of the most common reasons for reoperation. It also seems that women who have additional surgery to replace their implants (revision surgery) are more likely to have capsular contracture than women having their first augmentation or reconstruction. However, whether or not a woman experiences capsular contracture at all and with what degree of severity varies from woman to woman.

If you feel severe pain and/or firmness (usually Grades III and IV contracture), you may need surgery to correct the problem. This could mean that the surgeon has to remove the part of your breast tissue that has contracted around the implant (the scar tissue capsule), and you could lose some breast tissue during such a surgery. During such surgery, it is possible that your implant(s) would need to be replaced. Even after having surgery to fix contracture problems once, contracture may happen again.

The capsular contracture Baker Grade III/IV rates in Mentor's MemoryGel™ Breast Implant Core Study through 2, 4, and 6 years are presented in Table 3. The MemoryGel™ Breast Implant Core Study reported a 10% risk of experiencing Baker Grade III or IV capsular contracture for primary augmentation patients through 6 years after receiving implants. For revision-augmentation patients, the risk was 22% through 6 years. This means that 10 out of 100 primary augmentation patients and 22 out of 100 revision-augmentation patients may experience Baker Grade III or IV capsular contracture within 6 years after receiving implants.

Table 3.
Capsular Contracture Baker Grade III/IV Rates by Patient

Cohort	2 Year	4 Year	6 Year
Primary Augmentation, N=552	8.0%	9.0%	9.8%
Revision-Augmentation, N=145	18.2%	19.7%	22.1%

More details on capsular contracture results from the MemoryGel™ Breast Implant Core Study are found in Section 8.4.

• Rupture

Breast implants are considered to have ruptured when the implant shell develops a tear or hole. Sometimes silicone gel can minimally leak or “bleed/diffuse” through the implant shell even if there is no obvious tear in the shell. This is called “gel bleed” or “gel diffusion.”

Implants could rupture any time after your implant surgery, but the longer the implants are in place, the higher the possibility that the implants will rupture or the gel will leak. Breast implants may rupture or leak because of any of these reasons:

- Damage by surgical instruments at the time of implantation or during any subsequent surgical procedure,
- Stress to the implant during implant surgery that weakens it,
- Folding or wrinkling of the implant shell,
- Excessive force to the chest (for example, during closed capsulotomy, which is a procedure that should not be used),
- Trauma (such as being in a car accident),
- Compression during a mammogram,
- Severe capsular contracture, or
- Normal use over time.

Sometimes there are symptoms associated with gel implant rupture that you or your doctor can notice. Sometimes your implants could rupture without you feeling the rupture or noticing any changes in your breasts. In some of these instances even your doctor might not be able to tell that a rupture has occurred. A rupture that has no symptoms is called a “silent” rupture.

Mentor has done studies to better understand what causes breast implants to rupture or leak gel. These studies might not have identified all the causes of rupture and these studies are continuing.

When silicone gel breast implants rupture, most of the silicone gel usually stays in the implant, and if any silicone does escape through a tear or hole, most of the gel stays within the scar tissue (capsule) around the implant.^{1,2} Sometimes, the gel does not stay there and may move to other areas around the body (gel migration). There have been rare reports of gel moving to nearby tissues such as the chest wall, armpit, or upper abdominal wall, and to more distant locations down the arm or into the groin. One group of researchers found silicone in the livers of women with silicone gel breast implants.³

Sometimes silicone travels into the lymph nodes. When silicone gel moves into the lymph nodes, they may become enlarged. When silicone gel moves into lymph nodes or other parts of the body, small hardened lumps of silicone (called silicone granulomas) may be felt. These lumps are NOT cancer, but it can be hard to tell them from cancerous lumps just by feeling them. If you feel any lumps in your breasts, around your breasts, in your armpits or anywhere in your body, your doctor should examine them. Based on your presentation and history, your surgeon may elect to observe you for a period of time or they may begin a work up to find out why the lymph nodes are enlarged. Reasons for enlargement are varied and it may be a result of infection, silicone migration to the lymph node, certain types of cancer, or other causes. Your doctor may have to remove a small amount of tissue from the lump(s) (called taking a biopsy) to find out if the lump is cancer. It is important that you discuss your implant history with your surgeon as well as the details of your lymph node enlargement.

Studies have been done to find out what, if any, effects migrated silicone gel has on the body.^{3,4,5,6,7} In most cases, no serious problems were reported. Several studies report that some women with migrated silicone gel experienced breast hardness, numbness and/or tingling in their extremities, and some seemed more sensitive to sunlight.^{3,6,8} In a few cases, migrated gel has caused nerve damage, hard silicone nodules (granulomas) in the body, and/or breakdown of the body tissues around the gel.⁷

Most doctors and researchers agree that there is NO evidence that ruptured implants or migrated gel causes any disease that affects the whole body (systemic disease) like Connective Tissue Disease (CTD) or cancer. However, one group of researchers^{4,5} reported that women who had migrated silicone gel had a higher risk of getting a CTD. This is discussed more fully in Section 4.2.

Studies on breast implants that women have had for a long time suggest that gel bleed may play a role in capsular contracture.⁹ However, complication rates for silicone gel breast implants are similar to or lower than those for saline-filled breast implants (which do not have silicone gel and, therefore, do not have gel bleed).

Rupture rate information on Mentor's MemoryGel™ Breast Implants is provided in a published European study known as the U.K. Sharpe and Collis Study.² Silent rupture was assessed by MRI on 149 patients implanted with textured MemoryGel™ Breast Implants. The average age of the implants was approximately 10 years. The results suggest that by 13 years approximately 12% of implants will have ruptured. All ruptures were confirmed to be intracapsular. For more information on MemoryGel™ Breast Implants, refer to the MENTOR® MEMORYGEL™ BREAST IMPLANT CORE STUDY section of this brochure.

• Reoperation

It is likely that you will need additional surgery (a reoperation) at some point after your first breast implant surgery, either to correct a problem with or replace your breast implants. Patients may decide to change the size or type of their breast implants, requiring additional surgery. Problems such as rupture, capsular contracture, asymmetry (lack of proportion of shape, size, and/or position between the two breasts), hypertrophic scarring (irregular, raised scar), infection, and shifting can require additional surgery. Some changes to your breast(s) after having breast implants are irreversible (cannot be changed or fixed). These may include dimpling, puckering, wrinkling, or the appearance that the breast is empty or deflated.

The MemoryGel™ Breast Implant Core Study reported a 19% risk of experiencing reoperation for primary augmentation patients through 6 years after receiving implants. This means that 19 out of 100 primary augmentation patients may experience reoperation within 6 years after receiving implants. The most common reasons for reoperation were capsular contracture Baker Grade III/IV and patient request for size/style change. For revision-augmentation patients, the risk was 33% through 6 years. This means that 33 out of 100 revision-augmentation patients may experience reoperation within 6 years after receiving implants. The most common reasons for reoperation were capsular contracture Baker Grade III/IV and breast mass. More details on reoperation from the MemoryGel™ Breast Implant Core Study are found in Section 8.5.

• Implant Removal

Your breast implants may be removed (with or without being replaced) at some point during the course of your life. You and your doctor may decide to remove an implant or implants because of a complication or to improve the cosmetic result.

Because these are not lifetime devices, the longer you have your breast implants, the more likely it will be for you to have them removed for any reason, either because of dissatisfaction, an unacceptable cosmetic result, or a complication such as severe capsular contracture.

Women who have their breast implants removed often have them replaced with new implants, but some women do not. If you choose not to replace your implants, you may have cosmetically unacceptable dimpling, puckering, wrinkling, and/or other potentially permanent cosmetic changes of the breast following removal of the implant. Even if you have your implants replaced, implant removal may result in loss of breast tissue. Also, implant replacement increases your risks of future complications. For example, the risks of severe capsular contracture and reoperation increase for patients with implant replacement compared to first time placement. You should consider the possibility of having your implants replaced and its consequences when making your decision to have implants.

The MemoryGel™ Breast Implant Core Study reported a 7% risk of implant removal (including removal with replacement for a size exchange) for primary augmentation patients through 6 years. For revision-augmentation patients, the risk was 18% through 6 years. This means that 7 out of 100 primary augmentation patients may experience implant removal within 6 years after receiving implants, and 18 out of 100 revision-augmentation patients may experience implant removal within 6 years after receiving implants. More details on implant removal from the MemoryGel™ Breast Implant Core Study are found in Section 8.6.

- **Pain**

You will probably have some pain after your surgery. The intensity of the pain and the length of time it lasts vary from patient to patient. The pain may persist long after you have healed from surgery. In addition, improper implant size, placement, surgical technique, or capsular contracture may result in pain. Tell your surgeon if you have a lot of pain or if your pain does not go away.

- **Changes in Nipple and Breast Sensation**

Feeling in the nipple and breast can change after implant surgery. Nipples may become more or less sensitive. They may be painfully sensitive or feel nothing at all. These changes are temporary for many women, but for some, sensation may never be what it was before implant surgery. They may affect a woman's sexual response or ability to breastfeed. (See the paragraph on breastfeeding below.)

- **Cosmetic Changes**

You may not be satisfied with the way your breasts look or feel after your surgery. Unsatisfactory results such as scarring or asymmetry (note: asymmetry that exists before breast implant surgery may not be entirely correctable), wrinkling of the skin, implant displacement/migration, incorrect size, unanticipated shape and/or implant palpability/visibility may occur.

A surgeon can minimize the chances of these things happening by planning the surgery carefully and using good surgical techniques. You should understand the possible cosmetic results and discuss them carefully with your doctor before the surgery. Your surgeon cannot promise that after implant surgery your breast(s) will look exactly as you wanted them to look. Revision surgery may be the only way to improve a result you do not like.

- **Breastfeeding**

Breast implant surgery might interfere with your ability to successfully breastfeed. It is possible that you will produce less milk or not be able to produce milk at all. Some women with breast implants have also reported painful breastfeeding.^{9,10} If your surgeon uses an incision around the colored portion surrounding the nipple (periareolar surgical approach), it may further increase the chance of breastfeeding difficulties.

The Institute of Medicine (IOM) and The American College of Obstetricians and Gynecologists (ACOG) encourage women with breast implants to try breastfeeding. The IOM concluded, "Breastfeeding should be encouraged in all mothers when possible, including those with silicone breast implants. There is evidence that breast implantation may increase the risk of insufficient lactation,¹¹ but no evidence that this poses a hazard to the infant beyond the loss of breastfeeding itself. The evidence for the advantages of breastfeeding to infant and mother is conclusive."^{9,12} The MemoryGel™ Breast Implant Core Study collected information from patients who had babies after augmentation with MemoryGel™ Breast Implants. Ten of the 61 primary augmentation patients who attempted to breastfeed following breast implant surgery experienced difficulty with breastfeeding through 6 years in Mentor's MemoryGel™ Breast Implant Core Study. Two of the 10 the revision-augmentation patients who attempted to breastfeed after receiving breast implants had difficulty. Lactation experiences from the MemoryGel™ Breast Implant Core Study are also discussed more in Section 8.7.

• **Implant Extrusion**

Extrusion is when the breast implant comes through the skin. This can happen if your surgical wound has not healed properly or if the skin over your breast weakens. Radiation therapy has been reported to increase the chances of implant extrusion. Additional surgery is needed to fix implant extrusion. This can result in more scarring or loss of breast tissue. An extruding implant may have to be removed and not replaced.

• **Necrosis/Delayed Wound Healing**

Necrosis means that of most or all of the cells in a certain part of your body have died. In the case of implanted breasts, it means dead or dying breast tissue or skin. This can mean that the implant may extrude. Necrotic tissue must be surgically removed. The additional surgery may cause more scarring or loss of breast tissue. Your implant may have to be removed with or without being replaced.

Some patients may take a long time to heal after breast implant surgery. The longer it takes for your surgical wound to close and heal, the greater the risk for infection, implant extrusion, or necrosis. The normal time for wound healing is different for every patient. Infection, radiation, chemotherapy, smoking, taking steroids, and excessive heat or cold therapy can cause necrosis and delayed wound healing. Be sure to ask your surgeon how long he or she expects healing to take for you. If you do not heal in that timeframe, talk to your surgeon immediately.

• **Breast Atrophy/Chest Wall Deformity**

The breast implant pressing on the breast tissue may cause the tissue to become thinner. When this happens, you may be able to see and/or feel the breast implant through the skin. This tissue thinning can occur while implants are still in place or following implant removal without replacement.

The presence of breast implants can cause deformity that is noticeable, especially in very thin women.

Additional surgery may be needed to correct either of these conditions, which may mean more scarring, and removal with or without replacement of your breast implant(s).

• **Calcium Deposits**

Calcium deposits (hard lumps of calcium) may form in your breast(s) and may be painful. Calcium deposits form in women who have not had any breast surgery and in women who have had breast surgeries. They also become more common as women get older.

Calcium deposits do not mean you are ill, but they can be mistaken for cancer. It may be difficult to tell if they are calcium deposits or cancer just by feeling them. They can show up on mammograms as possible cancer lumps. If you have hard lumps, your doctor may have to operate in order to perform a biopsy (remove a small piece of the lump for testing) or to remove the lump(s). Tell your doctor about any lumps you feel in or around the breast or anywhere on your body.

• **Enlarged Lymph Nodes**

There are a large number of lymph glands in the body, but it is the lymph nodes in the armpit that drain the breast area of fluid. Some patients with breast implants have been found to have enlarged lymph nodes in the armpit. This is referred to as lymphadenopathy. It has been reported to occur in women with both ruptured and intact silicone gel breast implants. If an enlarged lymph node becomes painful, it may need to be surgically removed. You should report any painful or enlarged lymph nodes to your doctor.

Literature reports associate lymphadenopathy with both intact and ruptured silicone gel-filled breast implants. One study reported that armpit lymph nodes from women with both intact and ruptured silicone gel-filled implants had abnormal tissue reactions, granulomas, and

the presence of silicone.⁷ These reports were in women who had implants from a variety of manufacturers and implant models.

4.2 What Are Other Reported Conditions?

Mentor will continue its MemoryGel™ Breast Implant Core Study through 10 years. Mentor will update the information it publishes about its implants (including this patient brochure) with the results of this study. Contact your surgeon or Mentor (see Section 10 on Important Contact Information) for updates. Some women with breast implants have reported health problems that they believe are related to their implants, although the connection between their implants and their health problems has not been proven. Examples of such health problems include autoimmune diseases or connective tissue disease, cancer, or neurological problems (problems with the brain or nerves).

Studies have not shown that breast implants can cause these conditions. Most studies suggest that there is no connection between breast implants and these medical conditions. However, you should be aware of them. It is possible that there are risks that are not known and could be associated with breast implants in the future.

The information discussed in this section is based on studies published in the medical literature that include women with many different types, brands, and models of breast implants for augmentation and/or reconstruction.

The following potential long-term health effects of breast implants have been studied in relation to breast implants in general:

• Cancer

At this time, there is no scientific evidence that silicone gel breast implants increase the risk of any kind of cancer in women, but this possibility cannot be completely ruled out. Major research groups agree that silicone gel breast implants do not cause cancer.^{14,15,16,17}

• Breast Cancer

Patients with breast implants do not seem to have greater risk of developing breast cancer.^{18,19,20,21,22,23,24,25,26,27,28}

The Institute of Medicine (IOM) report (a comprehensive review of studies that looked at the safety of silicone gel breast implants since they were introduced in 1962) showed that breast cancer is no more common in women with implants than those without implants.

Some studies have suggested that breast implants may interfere with or delay breast cancer detection by mammography and/or biopsy. However, other studies reported that breast implants neither delayed breast cancer detection nor affected cancer survival.^{20,28,29,30,31}

• Brain Cancer

Most studies of brain cancer in women with silicone gel breast implants have found no increased risk.^{19,21,23,26,27,28,32} One study reported a higher rate of brain cancer in women with breast implants, compared to the general population.^{29,33} However, rates of brain cancer were not significantly higher in women with breast implants when compared to women who had other non-breast implant plastic surgeries.

• Lympho-Hematopoietic Cancers

Lympho-hematopoietic cancers are cancers that develop in the lymph nodes or certain blood cells. Lymph nodes and the affected cells are part of the body's immune system to fight infection. These kinds of cancers include non-Hodgkin's lymphoma, Hodgkin's disease, multiple myeloma, and leukemia. Although most studies have found no increased risk of these cancers for women with silicone gel breast implants,^{19,21,23,26,27,28} some reports have suggested a possible association between a type of anaplastic large cell lymphoma (ALCL) and breast implants.³⁴

Anaplastic Large Cell Lymphoma

If you have breast implants, you have a very small, but increased risk of developing breast implant associated anaplastic large cell lymphoma, or BIA-ALCL. BIA-ALCL is not breast cancer—it is a rare type of non-Hodgkin's lymphoma (cancer of the immune system). In most cases, BIA-ALCL is found in the scar tissue and fluid near the implant, but in some cases, it can spread throughout the body. In the cases that have spread beyond the scar tissue and fluid near the implant, rare cases of death have been reported.

Most patients were diagnosed with BIA-ALCL when they sought medical treatment for implant-related symptoms such as swelling, pain, lumps, or asymmetry that developed after their initial surgical sites were fully healed. In the cases known to FDA to date, BIA-ALCL was diagnosed years after the breast implant was placed. The earliest report was one year after implant placement and the latest was 23 years after the implant surgery. About half the cases occurred within the first 7 years after implant. BIA-ALCL was most often diagnosed in women who had textured implants. The textured implant may have been placed at the most recent surgery or at any other prior breast implant operation. Several journal articles explore the risk factors for BIA-ALCL, including the methods used to create surface texture of the implant and the role of biofilm in causing disease, among others.

If you develop swelling or pain around your breast implants, be sure to talk to your health care provider. Your health care provider should consider the possibility of BIA-ALCL if after you have recovered from your breast implant operation, you later notice changes in the way your breast looks or feels—including swelling or pain around the implant. If your health care provider suspects BIA-ALCL, they will refer you to an appropriate specialist for evaluation which may involve obtaining fluid and tissue samples from around your breast implant. If a diagnosis of BIA-ALCL is confirmed, the doctor will develop an individualized treatment plan for you. Because of the small number of cases worldwide and the variety of available treatment options, there is no single defined treatment. However, if you are diagnosed with BIA-ALCL, the National Comprehensive Cancer Network (NCCN) recommends removing the implant and the surrounding tissue.

If you have breast implants, you should monitor them and follow your routine medical care. You do not need to take any additional steps. It is not necessary to remove your breast implants if you have no symptoms and you have not been diagnosed with BIA-ALCL.

If you are diagnosed with BIA-ALCL, you can help the FDA understand the disease and the effectiveness of treatment.

You or your doctor should report all confirmed cases of BIA-ALCL to the FDA (<https://www.fda.gov/Safety/MedWatch/>). In some cases, the FDA may contact you for additional information. The FDA will keep the identities of the reporter and the patient confidential.

In addition, if you are diagnosed with BIA-ALCL, talk to your doctor about reporting it to the PROFILE Registry (<https://www.theptf.org/research/clinical-impact/profile.htm>). Every case of BIA-ALCL should be reported to the PROFILE Registry because this helps provide a better understanding of the disease.

If you are considering breast implant surgery, you should discuss the risks and benefits with your health care provider. You may also visit the FDA's Breast Implants website for additional information <https://www.fda.gov/MedicalDevices/ProductsandMedicalProcedures/ImplantsandProsthetics/BreastImplants/ucm064106.htm>.

For additional information on FDA's analysis and review of BIA-ALCL, please visit: <http://www.fda.gov/MedicalDevices/ProductsandMedicalProcedures/ImplantsandProsthetics/BreastImplants/ucm239995.htm>

• **Respiratory/Lung Cancer**

Several studies have found that women with silicone gel breast implants are not at greater risk for lung cancer.^{19,21,23,26,27,28} One study found an increased risk of respiratory/lung cancer

in women with breast implants^{29,33} compared to women who had other kinds of plastic surgery (non-breast implant). However, the risk of lung cancer was not higher than national lung cancer rates for the general population. Other studies of women in Sweden and Denmark have found that women who get breast implants are more likely to be current smokers than women who get breast reduction surgery or other types of cosmetic surgery^{35,36,37}; this may increase their risk for lung cancer. A recently published systematic review reported there is limited or suggestive evidence of an association between breast implants and lung cancer.⁷⁹

• Reproductive System Cancer

Reproductive system cancers in women are cancers of the cervix, ovaries, uterus, vulva, vagina, and other female genital organs. Most studies^{19,21,23,26,27,28} found that women with silicone gel breast implants have no greater risk of these cancers than women without implants. One study reported an increased incidence of cervical/vulvar cancer in women with breast implants.^{29,33}

• Other Cancers

Studies have examined other types of cancer including eye, urinary tract (related to the bladder and urethra), connective tissue (fibrous tissues like tendons, cartilage, and bone that provide structure and support throughout the body), and endocrine system (the parts of the body that make hormones). Studies show that women with silicone gel breast implants have no greater risk of these types of cancers compared to the general population.^{6,19,21,23,26,27,33,38}

• Connective Tissue Disease (CTD) and Disorders of the Immune System

The body's immune system protects the body from infection. It is a complicated system and includes a variety of different organs and cell types such as white blood cells and antibodies. Disorders of the body's immune system (also called autoimmune diseases) can cause CTDs when the patient's immune system mistakenly attacks parts of its own body, including the connective tissues of the body, like fibrous tissues (tendons), cartilage, and bones.

Autoimmune diseases include lupus (inflammation and tissue damage in different body parts and organs), rheumatoid arthritis (inflamed and deteriorating joints), polymyositis (inflamed, weakened muscles), dermatomyositis (inflamed, weakened muscles and skin); and progressive systemic sclerosis or scleroderma (damaged skin or organs because of excess collagen, the main protein in connective tissue).

Other CTDs include:

- Fibromyalgia (ongoing fatigue, widespread pain in muscles and joints, difficulty sleeping, and morning stiffness), and
- Chronic fatigue syndrome (ongoing mental and physical exhaustion, often with muscle and/or joint pain).

Some women with breast implants have experienced signs and symptoms that could be related to the immune system but that do not fit into a definable disease, like those listed above. These signs and symptoms include: painful or swollen joints, tightness, tingling, numbness, reddened swollen skin, swollen glands or lymph nodes, unusual or unexplained fatigue, swollen hands and feet, excessive hair loss, memory problems, headaches, and muscle weakness, pain, cramping and/or burning. Scientific expert panels and literature reports have found no evidence of a consistent pattern of signs and symptoms in women with silicone gel-filled breast implants.^{4,5,9,38,39,40}

The scientific evidence strongly supports the conclusion that there is no increased risk of CTDs or autoimmune disorders for women with silicone gel breast implants.^{4,5,9,38,41,42,43,44,45,46,47,48,49,50,51,52,53,54} Independent scientific panels and review groups have also concluded that the weight of the evidence shows no relationship between breast implants and CTDs, or at least if a risk cannot be absolutely excluded, it is too small to be measured.^{9,55,56} A recently published systematic review reported there is limited or suggestive evidence of an association between breast implants and rheumatoid arthritis.⁷⁹

• Effects on Children Born to Mothers with Breast Implants

It is not known if a small amount of silicone may move through the breast implant shell and pass into breast milk. There is no test for detecting silicone in breast milk that is considered accurate. There has been a study that measured silicon levels (one component of silicone). It did not indicate higher levels of silicon in breast milk from women with silicone gel breast implants when compared to women without implants.⁵⁷

In addition, questions have been raised about whether silicone gel breast implants could harm babies whose mothers had implants while pregnant. Two studies in humans have found that the risk of birth defects overall is not increased in children born after breast implant surgery.^{58,59} Although low birth weight was reported in a third study, other factors (for example, lower pre-pregnancy weight) may explain this finding.⁶⁰

Overall, there is no evidence that shows that silicone gel breast implants have any harmful effects on the children of implanted women.^{9,10,58,59,60}

• Suicide

Some studies have reported a higher incidence of suicide in women with breast implants, but it is not clear whether these suicides were associated with having silicone gel breast implants or some other underlying condition that can lead to suicide, depression and/or anxiety.^{29,61,62,63,64,65,66,67} One researcher⁶⁸ believes that some women who want cosmetic surgery suffer from a disorder, called body dysmorphic disorder (BDD), which may cause them to think about suicide or attempt suicide.

The strongest predictor for suicide is having been hospitalized for any psychiatric condition. One study found that women with breast implants were admitted to the hospital more often because of psychiatric problems before they even had their implant surgery, compared to women who had breast reduction or to the general population.⁶¹ This may be a contributing factor to the reported higher incidence of suicide in women with breast implants.

• Neurological Disease, Signs, and Symptoms

Some women with breast implants have complained of neurological symptoms such as difficulties with vision, sensation, muscle strength, walking, balance, thinking, or remembering things. Some have been diagnosed with diseases such as multiple sclerosis (which is an autoimmune disease that affects the nerves). Some of these women believe their symptoms are related to their implants. A scientific expert panel found that there is not enough reliable evidence that neurological problems may be caused by or associated with breast implants.⁹ Other researchers have found more evidence that silicone gel breast implants do NOT cause neurological diseases or symptoms.^{9,22,69} There is one published report of an increased risk of multiple sclerosis among women with silicone gel breast implants⁴⁴; these researchers did not find any increased risk of other neurological symptoms.

• Potential Health Consequences of Gel Bleed

Small quantities of low molecular weight (LMW) silicone compounds, as well as platinum (in zero oxidation state), have been found to diffuse (bleed) through an intact implant shell.^{9,70} The evidence is mixed as to whether there are any clinical consequences associated with gel bleed. For instance, studies on implants implanted for a long duration have suggested that such bleed may be a contributing factor in the development of capsular contracture⁹ and lymphadenopathy.⁷ However, evidence against gel bleed being a significant contributing factor to capsular contracture and other local complications is provided by the fact that there are similar or lower complication rates for silicone gel-filled breast implants than for saline-filled breast implants. Saline-filled breast implants do not contain silicone gel and, therefore, gel bleed is not an issue for those products. Furthermore, toxicology testing has indicated that the silicone material used in Mentor's implants does not cause toxic reactions when large amounts are administered to test animals. It should also be noted that studies reported in the literature have demonstrated that the low concentration of platinum contained in breast implants is in the zero oxidation (most biocompatible) state.^{71,72,73,74}

Mentor performed a laboratory test to analyze the silicones and platinum (used in the manufacturing process), which may bleed out of intact implants into the body. Over 99% of the LMW silicones and platinum stayed in the implant. The overall body of available evidence supports that the extremely low level of gel bleed is of no clinical consequence.

5. BENEFITS ASSOCIATED WITH BREAST IMPLANTS

Women choose primary breast augmentation surgery to increase the size and proportion of their breast(s). In addition, women choose revision-augmentation surgery (replacement of an existing breast implant) to correct or improve the result of a primary augmentation surgery.

According to literature reports, most women who have undergone breast implant surgery have reported high levels of satisfaction with their body image and the shape, feel, and size of their implants.⁷⁵

In Mentor's MemoryGel™ Breast Implant Core Study, the MemoryGel™ Breast Implants were demonstrated to be effective in increasing the size of a woman's breast and most primary and revision-augmentation patients were pleased with the results of their implant surgery, with 336 (98%) of the 342 primary augmentation and 89 (99%) of the 90 revision-augmentation patients who answered the patient satisfaction question indicating they would have the breast implant surgery again. The results also showed that most women who underwent primary augmentation with MemoryGel™ Breast Implants had improved body-image and greater self-acceptance, while those who underwent revision-augmentation experienced improved chest body-image.

For more information on the benefits of breast augmentation with Mentor's MemoryGel™ Breast Implants based on the results of the MemoryGel™ Breast Implant Core Study, refer to Section 8.3 of this brochure.

6. PREPARING FOR BREAST AUGMENTATION WITH SILICONE GEL BREAST IMPLANTS

Deciding to have breast augmentation with implants is an important personal decision that has both benefits and risks. You should decide whether it is the right choice for you after discussing all the options with your plastic surgeon and any other doctors who are treating you. This section will give you the information you need to make an informed choice and help you make a number of decisions that have to be made before your surgery.

6.1 Should I Have Breast Augmentation?

Breast augmentation with MemoryGel™ Breast Implants or MemoryGel™ Xtra Breast Implants is one option that may be available to you if you wish to enhance the appearance of your breasts. A breast revision-augmentation surgery may be appropriate if you have had a breast augmentation with implants but need to complete, improve upon, or correct a part of that first surgery (called the primary augmentation).

Whether breast augmentation is right for you depends on many things, some of them personal. You should take into account your medical condition, general health, lifestyle, how you feel emotionally, and your breast size and shape before surgery, as well as your hopes for breast size and shape after surgery. All of these things will affect the outcome of your surgery. Discuss your goals for breast augmentation with your doctors. You may also wish to consult your family and friends and breast implant support groups, to help you learn about the options and decide.

Many women who choose implants as part of their augmentation say their augmented breast(s) help them feel more self-confident, feel better about their bodies, and/or give them a greater feeling of well-being. Other women are not satisfied with their implants because of complications, like capsular contracture, rupture, or pain.

6.2 Breast Augmentation with Implants – Understanding the Procedure

The surgical procedure for breast augmentation consists of choices you and your surgical team (surgeon(s), nurses, anesthetist, etc.) will make as you plan your surgery. These choices include:

- The surgical setting (where the surgery will be performed, for example, in a hospital, surgery center, or doctor’s office),
- The type of anesthesia used,
- The location of the incisions made to insert the breast implants,
- How the implants will be placed in your breasts (subglandular or submuscular), and
- Whether your existing skin and/or breast tissue can cover implants.

Each of these is discussed in the sections that follow. The type of procedure that is available to you depends on your medical situation, breast shape and size, general health, lifestyle, and goals for the augmentation. Breast augmentation with silicone gel breast implants can usually be completed in a single surgery.

Surgical Setting

Breast augmentation surgery can be performed in a hospital, private surgery center, clinic, or in the surgeon’s office. Be sure you are comfortable with the location of the surgery before it happens. If you are considering having surgery in a private surgery center or office, you may want to see the area where the surgery will be performed.

Anesthesia

Breast implant surgery may be performed under general or local anesthesia. All anesthetics carry some risk. Discuss the risks and benefits of the anesthetic your surgeon and anesthetist recommend for you before the surgery.

Incision Sites

Figure 2 shows the three incision sites (location of cut through which the breast implant is inserted in your body) usually used for breast augmentation surgery.

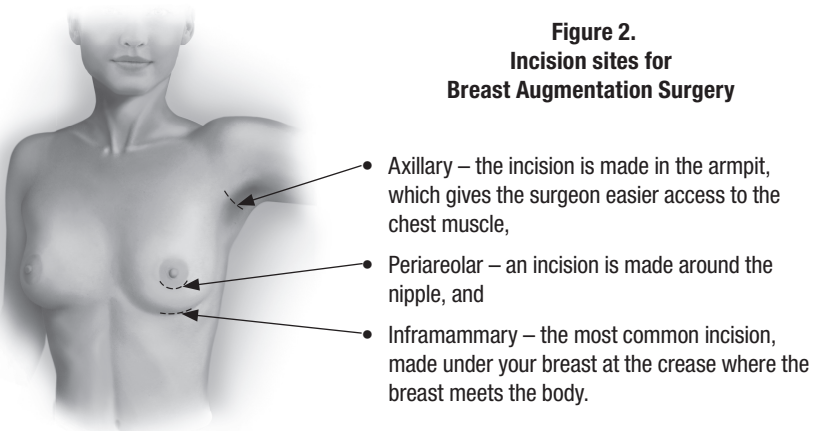

You may hear about a fourth incision site – the “periumbilical approach” (incision at your belly button). This way of placing breast implants has not been studied in Mentor’s MemoryGel™ Breast Implant Core Study and should not be used. It may cause damage to the implant shell.

The incision will be longer than the one typically made for breast augmentation with a saline or round silicone gel breast implant. Your surgeon can explain which incision site he or she recommends for you and talk about the pros and cons of each with you.

Implant Placement

As shown in Figure 3, breast implants are placed beneath your breast tissue, either on top of the chest muscle (subglandular placement) or underneath part or all of the chest muscle (submuscular placement).

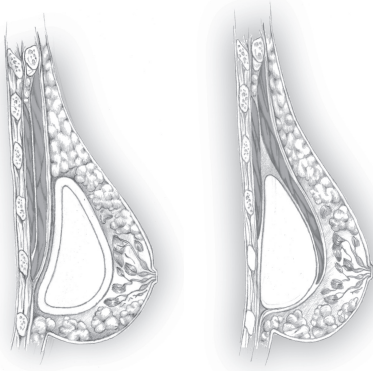

Subglandular

Submuscular

Figure 3.
Breast Implant Placement

Table 4 compares positive and negative aspects (pros and cons) of each method. The “best” placement depends on you and the characteristics of your body, the types of implants you choose, and your surgeon. Talk with your surgeon about his or her reasons for choosing one placement over the other and the advantages and disadvantages of each.

Table 4.
Comparison of Submuscular and Subglandular Placement of Breast Implants

Submuscular Placement	Subglandular Placement
<ul style="list-style-type: none"> • Surgery time may be longer • Recovery may be longer • May be more painful • Future re-operation may be more difficult • Implants may feel more like a natural part of the breast (be less “palpable”) • Capsular contracture may be less likely⁷ • It may be easier to image breast with mammography • If you have thin or weakened breast tissue, submuscular positioning may work better 	<ul style="list-style-type: none"> • Surgery time may be shorter • Recovery time may be shorter • May be less painful • Future reoperation may be easier • Implants may be more palpable (can feel the implant through breast tissue) • Capsular contracture may be more likely^{76,77} • It may be harder to image breast with mammography

6.3 Choosing the Right Implant for You

MemoryGel™ Breast Implants and MemoryGel™ Xtra Breast Implants are available in several different shapes, profiles, and sizes to help each woman achieve the result that is best for her body.

Table 5 lists the styles of MemoryGel™ Breast Implants and MemoryGel™ Xtra Breast Implants that are available.

Table 5.
MemoryGel™ Breast Implant Styles

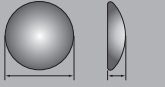
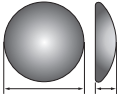
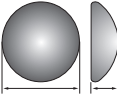
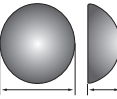
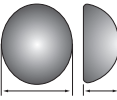
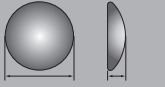
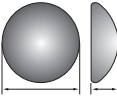
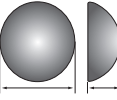
 Width Profile	MemoryGel™ Breast Implant Description Size Range
	Moderate Profile smooth and textured shell surface 100-800 cc Moderate Classic Profile smooth and textured shell surface 130-800 cc
	Moderate Plus Profile smooth and textured shell surface 100-800 cc
	High Profile smooth and textured shell surface 125-800 cc
	Ultra High Profile smooth shell surface 135-800 cc textured shell surface 135-700 cc
 Width Profile	MemoryGel™ Xtra Breast Implant Description Size Range
	Moderate Plus Profile Xtra smooth shell surface 115-755 cc textured shell surface 115-755 cc
	High Profile Xtra smooth shell surface 150-790 cc textured shell surface 150-765 cc

When you and your doctor decide what you want your breasts to look like after augmentation, your doctor can help you choose the right implant to get the effect you want. Your body type, height, and weight will be factors your surgeon considers to help you achieve the best result.

Implant Size, Shape and Surface

Your surgeon will examine your breast tissue and skin to figure out if you will have enough to cover the implant. It is possible that you will not have enough skin and/or breast tissue to cover the implant you desire. In this case, you may be offered several choices.

Breast implants that are too big for the amount of breast tissue or skin can cause problems: They can speed up the effects of gravity; your breasts may droop or sag earlier with implants that are too large. Implants that are too large can also cause implant extrusion, skin wrinkling, infection, and hematoma. You may be able to feel folds on the implant created by it being squeezed too tightly by the surrounding tissue and skin. If you do not have enough skin, and it is stretched too thin over the implant, you may be able to feel or see the edges of the implant under your skin surface after surgery.

6.4 Other Procedures at the Time of the Breast Augmentation

Your surgeon may recommend having other cosmetic procedures during the same surgery to get the best results from your breast implants. In some cases, breast implants alone may not give you the results you want. If, in the past, you have lost a lot of weight, been pregnant, or breastfed, you may have sagging, stretched, or extra skin that is not completely filled out by breast tissue. In this case, your doctor may recommend doing a breast lift (mastopexy) to remove excess skin from the rest of the breast tissue in one or both breasts.

During mastopexy, your surgeon will remove a piece of skin from your breast (usually from under the breast or around the nipple). Then he or she will use stitches to close the incision where the skin was removed. This lifts the whole breast or nipple location and tightens the skin over the breast. This might cause more scarring than just having implants placed and may lengthen your recovery time. Mastopexy (to one or both breasts) may be done at the same time as the primary augmentation or may be done at a later, follow-up procedure. It is not always best to do multiple procedures during one surgery. Your doctors can discuss the risks and benefits of this procedure with you.

6.5 Choosing a Surgeon

The following are types of questions you should consider when choosing a surgeon:

- In which states is he or she licensed to practice surgery?
- Has he or she completed residency requirements in plastic surgery from a recognized and accredited academic program?
- Is he or she board certified in the United States? If so, which board?
- How many breast augmentation surgeries does he or she perform each year?
- How many years has he or she been doing breast augmentation surgeries?
- What is the most common complication he or she encounters with breast augmentation patients?
- What is his or her reoperation rate for augmentation patients? And what is the most common type of reoperation that he or she performs in his or her practice?
- Will he or she perform all of my surgery in a hospital? (Many surgeons perform breast implant surgery or components of breast augmentation in their own outpatient surgery centers. Hospitals require surgeons to prove that they are properly trained before they can operate in the hospital.)

7. CARING FOR YOURSELF AFTER BREAST IMPLANT SURGERY

How you feel after your surgery and the level of care you need in the first few days vary from patient to patient and depend on the extent of your surgery. Your wounds will take several weeks or more to heal completely. Talk with your surgeon after your surgery about how to care for yourself and how long your recovery should take.

7.1 Postoperative Care in the Hours and Days After Surgery

The first few hours after your initial augmentation surgery will be spent recovering in the hospital. You may be there for several days or you may be able to go home sooner. During these first days after your surgery, you will need to follow some simple directions to take care of yourself. Your surgeon will give you specific directions about what to do. Follow your surgeon's directions.

If you have had general anesthesia, you will remain in the hospital or surgery center until the anesthesia wears off. You may have drains in your breasts so that fluid or blood will drain out of the wound at the incision site.

You will probably leave your surgery wearing a bandage to protect the wounds and support your breasts. Your surgeon will tell you how long to keep your breasts bandaged. Eventually, you will be able to wear a bra for support instead of the bandages. Your doctor will give you instructions about bathing or washing the area during the first few days. He or she may tell you not to take baths for a certain period of time.

Call your doctor immediately if you think you may have an infection. If your incision sites or breasts are red, swollen, hot, painful, or are weeping (draining white or yellow fluid) or if you have a fever, chills, aches, nausea, or vomiting, you may have an infection.

If you do not have any complications, you will probably be able to go back to most of your usual daily activities in 1 to 2 weeks after surgery.

7.2 Postoperative Care in the First Weeks After Surgery

In the weeks after your augmentation, the skin over your breasts may feel tight as it adjusts to your new breast size. After your stitches are removed, your doctor may tell you to massage your incision site(s) with a cream or lotion to keep the skin from drying out; this may make you more comfortable as well. Use the product(s) he or she recommends.

Your doctor may have special directions about avoiding exercise or activities that compress or put pressure on your breasts during the first weeks after surgery. Follow your doctor's directions.

7.3 Caring for Yourself in the Months and Years After Surgery

There are some things you should do to make sure your breasts stay healthy and to take care of your implants: mammograms, breast exams, and protecting your implants from certain types of damage. It will be important to monitor your breasts for breast cancer. Also monitor regularly for breast implant rupture.

Mammograms

A mammogram is a special way of x-raying the breast. Whether or not you have breast implants, having a mammogram is considered the best way to detect breast cancer. However, there are some special considerations for women with breast implants:

- Breast implants can make it harder to see breast cancer on a mammogram.
- Breast implants can make it harder for the technologist to perform the mammogram.

The machine that does a mammogram squeezes the breast to make it as flat as possible while taking a picture. The pressure from this squeezing could make your implant rupture or cause gel bleed. You must tell the technologist that you have silicone gel breast implants before the procedure. The technologist can then use special techniques to get the best possible views of your breast tissue. He or she can also take steps to reduce the likelihood that your implants will rupture due to the mammogram.

It is a good idea to have a mammogram before your breast implant surgery. This establishes a baseline to which future mammograms can be compared. You are also encouraged to have another mammogram 6 months to 1 year after your implant surgery to establish a baseline with the implant present.

After that, the recommendations for mammograms are the same as for women without implants; have a mammogram every 1 to 2 years, starting at age 40, or as advised by your doctor. When you go for a mammogram, do the following things to get the most reliable pictures of your breast(s):

When you schedule a mammogram, tell the office that you have breast implants. Find a mammographer who is experienced with imaging implanted breasts. (Your doctor should be able to help you find a qualified mammographer.) Your physician may request a "diagnostic"

mammogram instead of a “screening” mammogram because more pictures are taken for a diagnostic mammogram. Make sure your mammographer knows what type of implants you have and how they are placed (for example, on top of the chest muscle or underneath).

Carry your Device Identification Card (that you will receive after surgery) with you and show it to the mammographer.

Other Breast Exams

Perform self-breast exams regularly. Once a month, after your period ends, is a good time to examine your breasts.

You can find brochures about how to perform self-breast exams through your doctor, a women’s health clinic, or online. Your doctor can show you how to do a self-breast exam. Ask your doctor to help you learn to tell the difference between your breast implant and breast tissue. This will help you do your self-breast exams without squeezing your implant too much. If you see or feel that something has changed, talk to your doctor promptly.

It is important to have regular exams by a doctor as well. It may be hard for you to feel changes in your breast because the implant is there, especially if you have capsular contracture. The doctor will look at your breasts and palpate your breasts like in a self-exam to feel for any changes. If your doctor finds anything, he or she may refer you for a mammogram to help diagnose the change. Your doctor may also ask for an MRI if he/she suspects rupture.

Protecting Your Implants

To protect your implants, you should make sure that any healthcare practitioners (doctors, emergency medical technologists, nurses, massage therapists, acupuncturists, chiropractors, physical therapists, etc.) treating you know that you have silicone gel breast implants. If they do not know about your implants, they may damage them by accident and your implants could rupture. Carry your Device Identification Card with you and show it to healthcare practitioners before receiving treatment.

You should also protect your implants by guarding against any strong or repeated pressure on your breasts.

Things to Call Your Doctor About Right Away

Call your doctor immediately if you have:

- Signs of an infection,
- A lump,
- Skin around the nipple that has become dimpled or drawn in,
- Discharge from the nipple,
- Change in the position or shape of your implant, or
- Injury to your breast(s).

If your implant becomes damaged, it may have to be removed.

Physical Limitations

After you have healed from surgery, you should be able to carry on normal activities including sports. Avoid situations that put a lot of pressure on your breasts or may cause trauma to your breast. Ask your doctor if there are any activities he or she does not recommend.

7.4 Monitoring Your Implants for Rupture

Rupture is a rare occurrence with silicone gel breast implants. However, the following information will help you to monitor your implants for evidence of rupture.

Detecting Rupture

A variety of factors can cause your breast implants to develop a tear or hole in the shell. These tears or holes are usually called ruptures because they can allow silicone gel from inside the implant to exit your implant.

If your implant(s) ruptures, you may experience certain symptoms. Any of the following may indicate that your implant has ruptured: hard knots or lumps surrounding the implant or in the armpit, changes in breast size or shape, pain, tingling, swelling, numbness, burning, and/or hardening of the breast.⁷⁸

If you feel any of these symptoms, contact your doctor for an exam.

If your implant ruptures, it is more likely that you will not experience any symptoms and you will not even know your implant has ruptured. In these situations, even your doctor may not be able to determine that a rupture has occurred. This is referred to as a “silent” rupture.

MRI examination (taking pictures of your implants with a device similar to an x-ray machine) is the best way to tell if a silent rupture has happened. For this reason it is strongly recommended that you have an MRI the third year after your surgery and then every 2 years after that for as long as you have your breast implants.

What to Do if You Suspect an Implant Rupture

If you suspect that an implant has ruptured or if you suspect that silicone gel has moved out of your implants, call your doctor right away and schedule an exam. Your doctor may recommend an MRI or other kinds of tests to help diagnose possible rupture. MRI is currently considered the best way to diagnose rupture.

What to Do if the Implant Rupture Is Confirmed

If your doctor confirms that you have a ruptured implant or that silicone gel has bled (moved) out of your implant shell, he or she will talk with you about your options. As a precaution, Mentor recommends that ruptured implants be taken out permanently and either replaced with a new implant or not replaced, depending on your preference or medical need.

If your implant is taken out, your surgeon may also have to remove some of your breast tissue (the tissue capsule that forms around the breast implant), which will involve additional surgery, with associated risks and costs. In some cases, it may not be possible to replace your implants.

8. MENTOR'S CLINICAL STUDY RESULTS

As part of the marketing approval requirements for the MemoryGel™ Breast Implants, Mentor conducted the MemoryGel™ Breast Implant Core Study with patients who received the implants for augmentation (primary and revision) and reconstruction (primary and revision). The results of the study will provide you with useful information on the experience of other women who have received MemoryGel™ Breast Implants. The results of the MemoryGel™ Breast Implant Core Study should not be used to predict your own experience with the MemoryGel™ Breast Implants, but the information can be used as a general guide about what you may expect. Your own benefits and complications depend on many individual factors.

8.1 Overview of the Study

The MemoryGel™ Breast Implant Core Study is a prospective, 10-year, multicenter clinical study conducted to examine the safety and effectiveness of the MENTOR® MemoryGel™ Breast Implants in patients undergoing primary augmentation, primary reconstruction, revision-augmentation, and revision-reconstruction of the breast.

There are 1,008 patients participating in the MemoryGel™ Breast Implant Core Study. A total of 552 patients had primary augmentation, 145 patients had revision-augmentation, 251 patients had primary reconstruction, and 60 patients had revision-reconstruction. Of these patients, 202 primary augmentation patients, 56 revision-augmentation patients, 134 primary reconstruction patients, and 28 revision-reconstruction patients are assessed for implant rupture for MRI at years 1, 2, 4, 6, 8, and 10 after receiving implants.

Assessment of the safety of the MemoryGel™ Breast Implants is based on the incidence of complications, including device failures. Effectiveness was assessed based on changes in bra size, chest circumference, patient satisfaction, and measures of quality of life. Several scales

and questionnaires about these topics were used to collect information for analysis, including a global satisfaction question, the Rosenberg Self-Esteem Scale, the Body Esteem Scale, the Tennessee Self-Concept Scale (TSCS), and the Short Form Health Survey (SF-36).

The MemoryGel™ Breast Implant Core Study will continue to follow patients through 10 years after their breast implant surgery. Results provided here represent the first 6 years of data. This brochure will be updated as more information becomes available. You should also ask your surgeon if he or she has received any updated clinical information.

The following sections provide more information about the complications and benefits you may experience following augmentation with MENTOR® MemoryGel™ Breast Implants, based on the experiences of the augmentation patients in the MemoryGel™ Breast Implant Core Study.

8.2 What Are the 6-Year Follow-up Rates?

The study enrolled 552 primary augmentation patients and 145 revision augmentation patients. At the 6-year follow-up visit, data are reported for 64% of the eligible primary augmentation patients and 70% of the eligible revision-augmentation patients.

8.3 What Are the Benefits?

The benefits of MemoryGel™ Breast Implants were examined by measuring the change in bra size (in terms of cup size and chest circumference) and assessing patient satisfaction and quality-of-life (QoL). Patient satisfaction and QoL were determined using several scales and questionnaires before implantation and at scheduled follow-up visits (1, 2, 4 and 6 years after their surgery).

Primary Augmentation Patients

Most primary augmentation patients were pleased with the results of their implant surgery though 6 years. Three hundred and eleven out of the 552 patients enrolled were included in the analysis of cup size. Almost all (98%) had increased their bra size by at least one cup size. Three hundred and thirty-two of the 552 patients enrolled were included in the circumferential chest size analysis. The average increase in circumferential chest size was 2.9 inches (7.4 centimeters). In regards to overall satisfaction, 336 (98%) of the 342 primary augmentation patients who answered the patient satisfaction question indicated they would make the same decision to have breast surgery.

With regard to QoL measures at 6 years for primary augmentation patients, there was no significant change in the SF-36 or the total score of the TSCS. There was a significant increase in the total score and the positive attitude score for the Rosenberg Self Esteem Scale and the total score and chest and sexual attractiveness subscales for the Body Esteem Scale.

Revision-Augmentation Patients

Most revision-augmentation patients were pleased with the results of their additional implant surgery through 6 years. Bra size changes were not analyzed for revision-augmentation patients. Eighty-seven of the 145 patients enrolled were included in the circumferential chest size analysis. The average increase in circumferential chest size was 1.3 inches (3.2 centimeters). In regards to overall satisfaction, 89 (99%) of the 90 primary augmentation patients who answered the patient satisfaction question indicated they would make the same decision to have breast surgery.

With regard to QoL measures at 6 years for revision-augmentation patients, there was a significant decrease in the Mental Component Score of the SF-36, indicating a negative effect of treatment. There was a significant increase in the chest score of the Body Esteem Scale and no significant changes in the Rosenberg Self-Esteem Scale. For the TSCS, there was a significant decrease, suggesting a lessening in self-concept as measured by this assessment.

8.4 What Were the 6-Year Complication Rates?

The safety of MENTOR® MemoryGel™ Breast Implants was determined by assessing the incidence of complications, including device failures.

Primary Augmentation

The complications observed in women who had primary augmentation through 6 years are presented in Table 6. The most common reported complication within the 6 years after primary augmentation surgery was reoperation (19% or approximately 19 out of 100).

Table 6.
6-Year Complication Rates for Primary Augmentation Patients, N=552 Patients

Key Complications	%
Capsular Contracture Baker Grade III, IV	9.8
Infection	1.6
Implant Removal with or without Replacement	6.7
Implant Removal with Replacement with Study Device	3.7
Any Reoperation	19.1
Rupture (MRI Cohort) ¹	3.4
Other Complications ≥ 1%	%
Nipple Sensation Changes ²	11.8
Hypertrophic Scarring (irregular, raised scar)	6.8
Ptosis (sagging)	5.7
Breast Mass	4.7
Miscarriage	3.1
Hematoma	2.9
Breast Sensation Changes ²	2.8
Breast Pain ²	2.0
Lactation Difficulties	2.0
Capsular Contracture Baker Grade II with Surgical Intervention	1.5
New Diagnosis of Rheumatic Disease ³	1.3
Seroma	1.1
Wrinkling ²	1.1

¹ Rupture was assessed by MRI at 1, 2, 4 and 6 years (results provided in Table 10).

² Mild occurrences were excluded.

³ There were 9 diagnoses for the 7 primary augmentation patients: carpal tunnel syndrome, chronic fatigue, fibromyalgia (2 cases), Hashimoto's thyroiditis, hypothyroidism, other inflammatory arthritis, systemic lupus erythematosus, and thyroiditis.

Revision-Augmentation

The complications observed in women who had revision-augmentation through 6 years are presented in Table 7. The most common reported complication within the first 6 years after revision-augmentation surgery was reoperation (33% or approximately 33 out of 100).

Table 7.
6-Year Complication Rates for Revision-Augmentation Patients, N=145 Patients

Key Complications	%
Capsular Contracture Baker Grade III, IV	22.1
Infection	1.4
Implant Removal with or without Replacement	17.8
Implant Removal with Replacement with Study Device	8.9
Any Reoperation	33.1
Rupture (MRI Cohort) ¹	7.2
Other Complications ≥ 1%	%
Nipple Sensation Changes ²	12.9
Hypertrophic Scarring (irregular, raised scar)	7.7
Breast Mass	6.4
Capsular Contracture Baker Grade II with Surgical Intervention	5.0
Hematoma	2.8
Miscarriage	2.4
Granuloma	2.4
Wrinkling ²	2.2
Ptosis (sagging)	2.2
Delayed Wound Healing ²	2.1
Seroma	2.1
New Diagnosis of Breast Cancer	1.8
New Diagnosis of Rheumatic Disease ³	1.6
Lactation Difficulties	1.5
Breast Pain ²	1.4
Extrusion	1.4
Inflammation of Breast	1.4
Implant Malposition/Displacement	1.4
Breast Sensation Changes ²	1.4

¹ Rupture was assessed by MRI at 1, 2, 4 and 6 years (results provided in Table 10).

² Mild occurrences were excluded.

³ There were 3 diagnoses for the 3 revision-augmentation patients: celiac disease, fibromyalgia, and rheumatoid arthritis.

8.5 What Are the Main Reasons for Reoperation?

Patients may require a reoperation for a number of reasons, including size and/or style change, implant removal (with or without replacement), capsular contracture procedures, incision and drainage, implant repositioning, scar revision, etc. In addition, patients may require more than one surgical procedure during a given reoperation.

Primary Augmentation

In Mentor's MemoryGel™ Breast Implant Core Study, there were 141 reoperations performed in 104 patients. The risk of experiencing at least one reoperation for primary augmentation patients was 19% (approximately 19 out of 100 patients) through 6 years. Table 8 provides the main reasons for reoperation. The two most common reasons for reoperation through 6 years in these patients were capsular contracture Baker Grade III/IV and patient-requested size change.

Table 8.
Main Reasons for Reoperation in Primary Augmentation Patients

Primary Reason for Reoperation	Year 6 N=141 Reoperations¹ n (%)
Capsular Contracture Baker Grade III/IV	38 (27.0)
Size Change	17 (12.1)
Hypertrophic Scarring (irregular, raised scar)	16 (11.3)
Breast Mass	13 (9.2)
Hematoma/Seroma	12 (8.5)
Asymmetry	6 (4.3)
Capsular Contracture Baker Grade II	6 (4.3)
Implant Malposition	4 (2.8)
Ptosis (sagging)	4 (2.8)
Breast/Skin Lesions	4 (2.8)
Implant removal – patient request	3 (2.1)
Infection	3 (2.1)
Breast Pain	2 (1.4)
Calcification	2 (1.4)
Extrusion/Necrosis	2 (1.4)
Capsular Tear	1 (0.7)
Delayed Wound Healing	1 (0.7)
Drainage from Incision After Cat Scratched	1 (0.7)
Palpability	1 (0.7)
Previous Surgical Complication	1 (0.7)
Rupture	1 (0.7)
Suspected Rupture	1 (0.7)
Suture Complication	1 (0.7)
Wrinkling	1 (0.7)

¹All reoperations were counted, with the primary reason for each reoperation presented.

Revision-Augmentation

In Mentor's MemoryGel™ Breast Implant Core Study, there were 72 reoperations performed in 47 revision-augmentation patients. The risk of experiencing at least one reoperation for revision-augmentation patients was 33% (approximately 33 of 100 patients) through 6 years. Table 9 provides the main reasons for reoperation. The two most common reasons for reoperation through 6 years were capsular contracture Baker Grade III/IV and breast mass.

Table 9.
Main Reasons for Reoperation in Revision-Augmentation Patients

Primary Reason for Reoperation	Year 6 N=72 Reoperations ¹ n (%)
Capsular Contracture Baker Grade III/IV	20 (27.8)
Breast Mass	9 (12.5)
Size Change	7 (9.7)
Capsular Contracture Baker Grade II	5 (6.9)
Delayed Wound Healing	5 (6.9)
Hematoma/Seroma	5 (6.9)
Hypertrophic Scarring (irregular, raised scar)	3 (4.2)
Asymmetry	2 (2.8)
Breast Cancer	2 (2.8)
Extrusion	2 (2.8)
Implant Malposition/Displacement	2 (2.8)
Ptosis (sagging)	2 (2.8)
Infection	1 (1.4)
Patient Dissatisfied with Appearance	1 (1.4)
Rupture	1 (1.4)
Shape Change	1 (1.4)
Skin Lesions	1 (1.4)
Suspected Rupture	1 (1.4)
Unknown	1 (1.4)
Wrinkling	1 (1.4)

¹ All reoperations were counted, with the primary reason for each reoperation presented.

8.6 What Are the Main Reasons for Implant Removal?

Breast implants may be removed (with or without replacement) in response to a complication or to improve the cosmetic result.

Primary Augmentation

The main reasons for implant removal among primary augmentation patients in the MemoryGel™ Breast Implant Core Study through 6 years are shown in Figure 4. There were a total of 64 implants removed in 36 patients through 6 years. Of the 64 implants removed, 33 (52%) were replaced with a study device. The most common reason for implant removal through 6 years was patient requested size change (34 of the 64 implants removed).

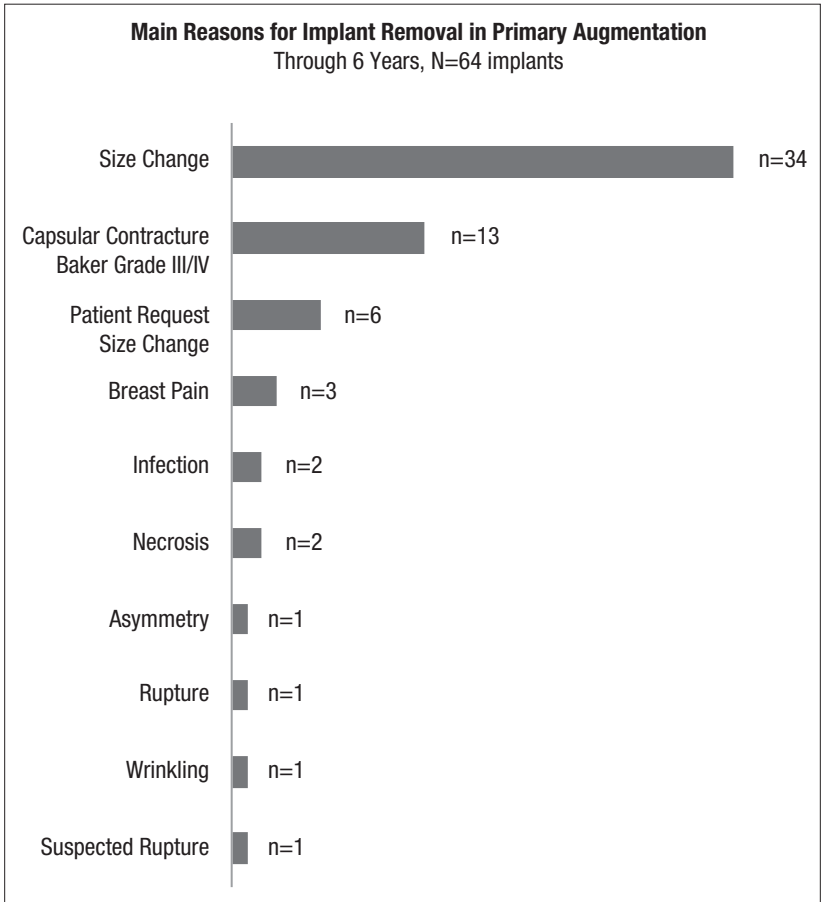
Figure 4.

Revision-Augmentation

The main reasons for implant removal among revision-augmentation patients in the MemoryGel™ Breast Implant Core Study through 6 years are shown in Figure 5. There were a total of 45 implants removed in 25 patients through 6 years. Of the 45 implants removed, 21 (47%) were replaced with a study device. The most common reason for implant removal through 6 years was patient-requested size change (15 of the 45 implants removed).

Figure 5.

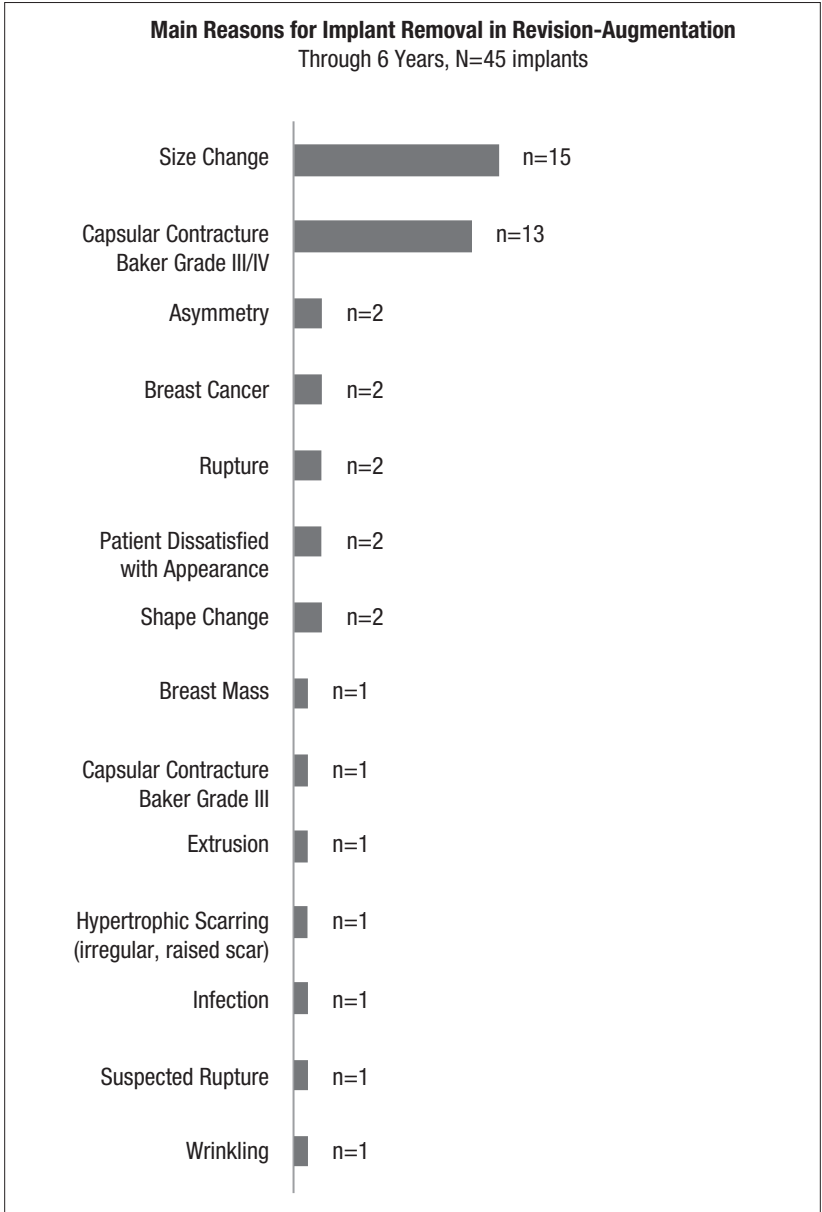

8.7 What Are Other Clinical Data Findings?

The MemoryGel™ Breast Implant Core Study evaluated several possible long-term health effects that have been reported in breast implant patients. These include rupture, cancer, CTD, CTD signs and symptoms, complications with lactation, reproductive complications, and suicide. These study endpoints, along with others, are being further evaluated as part of a post-approval study.

Rupture

In the MemoryGel™ Breast Implant Core Study, there are 202 primary augmentation patients and 56 revision-augmentation patients enrolled in an MRI cohort study who have routine MRI screenings of their implants to track rupture (scheduled at 1, 2, 4, 6, 8, and 10 years). At 1, 2, 4, and 6 years, the overall follow-up rates for the MRI cohort across all indications were 38% (161 of 420 expected due), 78% (327 of 418 expected due), 67% (273 of 408 expected due), and 53% (217 of 406 expected due), respectively.

For primary augmentation patients in the MRI cohort, the estimated rate of suspected or confirmed rupture was approximately 3% through 6 years. This means that through 6 years, an estimated 3 of every 100 primary augmentation patients will have a ruptured breast implant. For revision-augmentation patients, the estimated rate of suspected or confirmed rupture was approximately 7% through 6 years. This means that through 6 years, an estimated 7 of every 100 revision-augmentation patients will have a ruptured breast implant. The specific estimated rates of suspected or confirmed rupture through 1, 2, 4, and 6 years are presented in Table 10.

Table 10.
Complication Rates for Rupture by Patient in MRI Cohort

Cohort	1 Year %	2 Year %	4 Year %	6 Year %
Primary Augmentation, N=202	0	0	0.7	3.4
Revision-Augmentation, N=56	0	2.0	4.3	7.2

Overall, there have been 19 suspected or confirmed ruptured implants among 16 of the patients (4 primary augmentation, 3 revision-augmentation, 8 primary reconstruction, and 1 revision-reconstruction) participating in the MRI cohort and 16 suspected or confirmed ruptured implants among 14 of the patients (2 primary augmentation, 1 revision-augmentation, 10 primary reconstruction, and 1 revision-reconstruction) participating in the non-MRI cohort. Of the 35 suspected or confirmed ruptured implants in the overall study, 4 cases were indeterminate for extracapsular silicone by MRI. There were no cases of migrated gel. The rupture rate beyond 6 years in Mentor's MemoryGel™ Breast Implant Core Study continues to be investigated.

Rupture rate information on Mentor's MemoryGel™ Breast Implants is also provided in a published European study known as the U.K. Sharpe and Collis Study.² Silent rupture was assessed by MRI on 149 patients implanted with textured MemoryGel™ Breast Implants. The average age of the implants was approximately 10 years. The results suggest that by 13 years approximately 12% of implants will have ruptured. All ruptures were confirmed to be intracapsular.

Cancer

There were no primary augmentation patients and 2 revision-augmentation patients with new diagnoses of breast cancer through 6 years in Mentor's MemoryGel™ Breast Implant Core Study. There were no reports of other new cancers, such as brain, respiratory, or cervical/vulvar in any cohort.

Through 6 years, there were no reports of ALCL in any patient cohort in the MemoryGel™ Breast Implant Core Study.

Connective Tissue Disease (CTD)

In the MemoryGel™ Breast Implant Core Study through 6 years, there were 7 primary augmentation patients and 3 revision-augmentation patients reported to have a new diagnosis of CTD by a rheumatologist. There were 9 diagnoses for the 7 primary augmentation patients: carpal tunnel syndrome (within 5 years), chronic fatigue (within 1 year), fibromyalgia (2 cases – within 3 and 4 years), Hashimoto's thyroiditis (within 2 years), hypothyroidism (within 2 years), other inflammatory arthritis (within 5 years), systemic lupus erythematosus (within 4 years), and thyroiditis (within 2 years). There were 3 diagnoses for the 3 revision-augmentation patients: celiac disease (within 6 years), fibromyalgia (within 3 years), and rheumatoid arthritis (within 3 years). It cannot be concluded that these CTD diagnoses were caused by the implants because there was no comparison group of similar women without implants.

CTD Signs and Symptoms

Compared to before having implants, the following significant changes in individual signs and symptoms were found in the rheumatologic symptoms and physical examination findings after adjusting for the age effect: an increase for combined pain among primary augmentation patients and an increase for joint pain and fatigue among overall patients (augmentation and reconstruction). No statistically significant differences for individual signs and symptoms were found for the revision-augmentation patients.

The MemoryGel™ Breast Implant Core Study was not designed to evaluate the cause and effect associations because there is no comparison group of women without implants, and because other contributing factors, such as medications and lifestyle/exercise, were not studied. Therefore it cannot be determined whether any differences are due to the implants. However, you should be aware that you may experience an increase in symptoms after receiving breast implants.

Lactation Complications

Lactation complications, including difficulties with breastfeeding, were examined in the MemoryGel™ Breast Implant Core Study. Ten of the 61 primary augmentation patients who attempted to breastfeed following breast implant surgery experienced difficulty with breastfeeding through 6 years in Mentor's MemoryGel™ Breast Implant Core Study. Two of the 10 revision-augmentation patients who attempted to breastfeed after receiving breast implants had difficulty.

Reproduction Complications

Reproduction complications that were examined in the MemoryGel™ Breast Implant Core Study include miscarriage and having a stillborn baby. Sixteen primary augmentation patients and 3 revision-augmentation patients reported a miscarriage in Mentor's MemoryGel™ Breast Implant Core Study through 6 years.

Suicide

There were no reports of suicide in primary augmentation or revision-augmentation patients in the MemoryGel™ Breast Implant Core Study through 6 years.

9. WHAT TO DO IF YOU HAVE A PROBLEM

If you have a problem with your breast implant(s), tell your doctor about it immediately. Your doctor may need to examine you.

(Write your doctor's contact information here)

In addition to informing your doctor, you can report a problem to Mentor and/or to the U.S. Food and Drug Administration (FDA). Your doctor or other healthcare provider may do this or you may report it yourself.

You can report any serious problem directly to the FDA through its voluntary reporting program called MedWatch. (See <http://www.fda.gov/medwatch>). There is a special form you must use for voluntary reporting (FDA Form 3500). You can obtain it several ways:

- Complete Form 3500 and submit it online at <https://www.accessdata.fda.gov/scripts/medwatch/medwatch-online.htm>
- Download Form 3500 from the website <https://www.accessdata.fda.gov/scripts/medwatch/medwatch-online.htm> and print it out, fill it in, and send it to the FDA, or
- Call the FDA to get a reporting package at 1-800-FDA-1088 (1-800-332-1088).

If you need to complete a Form 3500, the FDA recommends that you take Form 3500 to your doctor, who can help you to complete it.

10. WHERE TO FIND MORE INFORMATION

Mentor has more information about its MemoryGel™ Breast Implants and MemoryGel™ Xtra Breast Implants that are available to you. You may request a copy of the package insert given to surgeons that describes how to use the MemoryGel™ Breast Implants and MemoryGel™ Xtra Breast Implants. It also discusses safety information and research performed on implants in general and on MENTOR® MemoryGel™ Breast Implants and MENTOR® MemoryGel™ Xtra Breast Implants in particular. Note that this document is intended only for surgeons, so it has a large amount of undefined medical and technical language.

You can find more detailed information on the studies (in animals and humans or other laboratory testing) done on MemoryGel™ Breast Implants in Mentor's Summary of Safety and Effectiveness Document (SSED) on the FDA's website at: <http://www.fda.gov/breastimplants>

You can find these resources on Mentor's website at <http://www.mentorwllc.com> or through Mentor's Consumer Affairs Department (866-250-5115).

There are several other sources of information about breast implants and breast implant surgery.

The U.S. Food and Drug Administration (FDA) has published a breast implant complications booklet titled "Breast Implants: Local Complications and Adverse Outcomes." It contains

descriptions of the risks of having breast implants (similar to this brochure) and links to more information. The booklet is available through the FDA website at:

<http://www.fda.gov/breastimplants>

Professional organizations for surgeons offer helpful information on their websites about making decisions about plastic/cosmetic surgery and about choosing a surgeon. You can find this information at the following websites:

The American Society for Aesthetic Plastic Surgery - <http://www.surgery.org>

American Society of Plastic Surgeons - <http://www.plasticsurgery.org>

In 2000, the Institute of Medicine (IOM) published a comprehensive review of studies that have looked at the safety of silicone gel breast implants. The report is available on the website <http://www.iom.edu/Reports/1999/Safety-of-Silicone-Breast-Implants.aspx>

Patient groups offer support and information to women who have had problems with their breast implants. Several such websites are listed at: <http://www.fda.gov/breastimplants>

11. MENTOR'S IMPLANT TRACKING PROGRAM

Each breast implant is assigned a unique serial number that allows Mentor to identify the implant(s) and locate important information about how and when they were manufactured. Mentor has developed a breast implant tracking program to help facilitate contacting you with updated information if needed.

11.1 Breast Implant Tracking

At the time of your breast implant surgery, you will be asked to participate in Mentor's breast implant tracking program. This will help to ensure that Mentor has a record of your contact information and can contact you in the event there is updated information on your breast implant(s) that you need to know about.

Federal regulations require Mentor to track its MemoryGel™ Breast Implants and MemoryGel™ Xtra Breast Implants. Your surgeon will report the serial number(s) of your breast implants to Mentor, along with the date of your surgery, your personal contact information, and contact information about his or her practice. Mentor maintains this information in a confidential manner.

Your doctor or his or her staff will fill out the Device Tracking Form and return it to Mentor.

11.2 Device Identification Card

After your surgery, your surgeon will provide you with a card that contains important information about your breast implants. This card will have the catalog and serial number of your implants, along with other information. Carry the card with you and show it to doctors or other healthcare providers when you visit them. It will help them treat you appropriately and protect your breast implants during any medical treatment you need in the future.

If you have your breast implants replaced, you will get a new Device Identification Card for those implants.

Your doctor should keep a copy of the Device Identification Card with your medical records.

Please inform Mentor whenever your contact information, e.g., mailing address, email, etc., changes so that we may keep you up to date with important information about your breast implant(s).

12. IMPORTANT CONTACT INFORMATION

Your MemoryGel™ Breast Implants and MemoryGel™ Xtra Breast Implants are manufactured for and sold by:

Mentor Worldwide LLC

33 Technology Drive

Irvine, CA 92618 USA

(800) MENTOR8

www.mentorwwllc.com

Your surgeon's name and contact information:

13. WARRANTY INFORMATION

Mentor's Lifetime Product Replacement Policy and Advantage Limited Warranties provide limited replacement and limited financial reimbursement in the event of shell leakage or breakage resulting in breast implant rupture. For more information, please contact Mentor's Consumer Affairs Department at (866) 250-5115 or visit www.mentorwwllc.com

This page is intentionally left blank.

14. ACKNOWLEDGMENT OF INFORMED DECISION

ACKNOWLEDGMENT OF INFORMED DECISION (Copy for Patient File)

I understand that this patient brochure provided by Mentor is intended to provide information regarding the benefits and risks of silicone gel breast implants. I understand that some of this information is about breast implants in general and some is specific to Mentor's breast implants. I understand that choosing to have augmentation breast surgery with implants involves both benefits and risks. I also understand that scientists and doctors have not been able to identify or quantify all of the risks of breast augmentation with implants and that, over time, additional information may become available.

I have had adequate time to review and understand the information in this brochure and my questions and concerns have been addressed by my doctor. I have considered alternatives to augmentation surgery, including the use of external prostheses or surgery with saline-filled breast implants, and I am choosing to proceed with silicone gel breast implant surgery.

By circling my response for each statement below and signing below, I acknowledge that:

- Y/N** I have had adequate time to read and fully understand the information in this brochure,
- Y/N** I have had an opportunity to discuss this information with my surgeon and to ask any questions I may have,
- Y/N** I have carefully considered options other than augmentation surgery with breast implants and have decided to proceed with silicone gel breast implant surgery,
- Y/N** I have been advised to wait an adequate amount of time after reviewing and considering this information before scheduling my silicone gel breast implant surgery,
- Y/N** I will retain this brochure, and I am aware that I may also ask my surgeon for a copy of this signed acknowledgment.

Patient Name (Printed)

Patient Signature*

Date

*A patient must be at least 22 years old for primary and revision breast augmentation with silicone gel breast implants.

By my signature below, I acknowledge that:

- My patient has been given an opportunity to ask any and all questions related to this brochure, or any other issues of concern;
- All questions outlined above have been answered "Yes" by my patient;
- My patient has had an adequate amount of time before making her final decision, unless an earlier surgery was deemed medically necessary, and
- This *Acknowledgment of Informed Decision* will be retained in my patient's permanent record.

Implanting Surgeon Name (Printed)

Implanting Surgeon Signature

Date

This page is intentionally left blank.

ACKNOWLEDGMENT OF INFORMED DECISION (Copy for Patient)

I understand that this patient brochure provided by Mentor is intended to provide information regarding the benefits and risks of silicone gel breast implants. I understand that some of this information is about breast implants in general and some is specific to Mentor's breast implants. I understand that choosing to have augmentation breast surgery with implants involves both benefits and risks. I also understand that scientists and doctors have not been able to identify or quantify all of the risks of breast augmentation with implants and that, over time, additional information may become available.

I have had adequate time to review and understand the information in this brochure and my questions and concerns have been addressed by my doctor. I have considered alternatives to augmentation surgery, including the use of external prostheses or surgery with saline-filled breast implants, and I am choosing to proceed with silicone gel breast implant surgery.

By circling my response for each statement below and signing below, I acknowledge that:

- Y/N** I have had adequate time to read and fully understand the information in this brochure,
- Y/N** I have had an opportunity to discuss this information with my surgeon and to ask any questions I may have,
- Y/N** I have carefully considered options other than augmentation surgery with breast implants and have decided to proceed with silicone gel breast implant surgery,
- Y/N** I have been advised to wait an adequate amount of time after reviewing and considering this information before scheduling my silicone gel breast implant surgery,
- Y/N** I will retain this brochure, and I am aware that I may also ask my surgeon for a copy of this signed acknowledgment.

Patient Name (Printed)

Patient Signature*

Date

*A patient must be at least 22 years old for primary and revision breast augmentation with silicone gel breast implants.

By my signature below, I acknowledge that:

- My patient has been given an opportunity to ask any and all questions related to this brochure, or any other issues of concern;
- All questions outlined above have been answered "Yes" by my patient;
- My patient has had an adequate amount of time before making her final decision, unless an earlier surgery was deemed medically necessary, and
- This *Acknowledgment of Informed Decision* will be retained in my patient's permanent record.

Implanting Surgeon Name (Printed)

Implanting Surgeon Signature

Date

This page is intentionally left blank.

15. INDEX

- Alternatives to Breast Implantation: 13, 47, 49
- Anaplastic Large Cell Lymphoma (ALCL): 24, 25, 42
- Anesthesia: 14, 16, 28, 32
- Asymmetry: 18, 21, 22, 23, 38, 39, 40, 41
- Autoimmune Disease: 11, 24, 26, 27
- Axillary Incision: 29
- Benefits: 10, 11, 12, 25, 27, 28, 31, 34, 35, 47, 49
- Biopsy: 20, 23, 24
- Body Dysmorphic Disorder (BDD): 27
- Breast Augmentation: 10, 11, 13, 14, 16, 18, 19, 21, 22, 24, 27, 28, 31, 32, 34, 35, 36, 37, 38, 39, 41, 42, 43, 47, 49
- Breastfeeding/Lactation: 12, 14, 15, 16, 17, 22, 43
- Breast Implant: 10, 11, 12, 13, 18, 19, 20, 21, 22, 23, 24, 25, 26, 27, 28, 30, 31, 32, 33, 34, 35, 36, 39, 42, 43, 44, 45, 46, 47, 49
- Breast Implant Styles: 30
- Breast Mass: 14, 16, 21, 36, 37, 38, 39, 41
- Breast Reconstruction: 10, 11, 19, 24, 34, 35, 42, 43
- Breast Self-Exams: 33
- Breast Tissue Atrophy: 23
- Calcium Deposits/Calcification: 23
- Cancer: 11, 12, 13, 17, 20, 21, 23, 24, 25, 26, 32, 37, 39, 41, 42
- Capsular Contracture: 13, 14, 15, 16, 18, 19, 20, 21, 22, 27, 28, 30, 33, 36, 37, 38, 39, 40, 41
- Capsule: 19, 20, 34
- Capsulotomy: 13, 20
- Chest Wall Deformity: 23
- Complications: 12, 13, 14, 15, 16, 17, 18, 21, 27, 28, 32, 34, 35, 36, 37, 42, 43, 44
- Congenital Anomaly: 11
- Connective Tissue Disease (CTD): 21, 26, 42, 43
- Contraindications: 11
- CTD Signs and Symptoms: 42, 43
- Delayed Wound Healing: 14, 16, 17, 23, 37, 38, 39
- Device Identification Card: 33, 45
- Device Tracking: 45
- Effects on Children: 26
- Fibromyalgia: 26, 43
- Fibrous Tissue: 25, 26
- Food and Drug Administration (FDA): 25, 44, 45
- Gel Bleed/Gel Diffusion: 20, 21, 27, 32
- Gel Migration: 20
- Granuloma: 17, 20, 23, 37
- Hematoma: 13, 14, 15, 16, 18, 19, 31, 36, 37, 38, 39
- Implant Displacement: 22
- Implant Extrusion: 17, 23, 31
- Implant Palpability: 22
- Implant Removal: 12, 14, 15, 16, 17, 18, 21, 22, 23, 36, 37, 38, 39, 40, 41
- Implant Rupture: 14, 16, 19, 20, 32, 34, 35, 46
- Infection: 11, 14, 15, 16, 17, 18, 19, 20, 21, 23, 24, 26, 31, 32, 33, 36, 37, 38, 39, 40, 41
- Inframammary Incision: 29
- Intracapsular Rupture: 21, 42
- Low Molecular Weight (LMW) Silicone: 27
- Lymphadenopathy: 23, 27
- Magnetic Resonance Imaging (MRI): 12, 13, 21, 33, 34, 35, 36, 42
- Mammography: 12, 24, 33
- Mastopexy: 13, 31
- MedWatch: 44
- MENTOR® MemoryGel™ Breast Implant Core Study: 10, 13, 18, 19, 21, 22, 24, 27, 28, 34, 35, 37, 38, 39, 41, 42, 43
- Necrosis: 14, 16, 17, 23, 38, 40
- Neurological Disease: 27
- Pain: 13, 14, 15, 16, 17, 18, 19, 22, 23, 25,

26, 28, 30, 32, 34, 36, 37, 38, 40, 43

Periareolar Incision: 22, 29

Periumbilical Approach: 29

Plastic Surgery: 25, 31, 45

Platinum: 27

Postoperative Care: 32

Precautions: 11

Reoperation: 14, 15, 16, 17, 18, 19, 21, 30,
31, 36, 38, 39

Reproduction Complications: 43

Revision-Augmentation: 10, 11, 13, 16, 18,
19, 21, 22, 27, 28, 35, 36, 37, 38, 39, 41,
42, 43

Risks: 10, 11, 12, 13, 14, 16, 21, 24, 25, 28,
31, 34, 44, 47, 49

Rupture: 12, 13, 15, 16, 18, 19, 20, 21, 23,
28, 32, 33, 34, 35, 36, 38, 39, 40, 41,
42, 46

Saline: 13, 21, 27, 47, 49

Satisfaction: 27, 35, 36

Scar Revision: 14, 16, 37

Scarring: 14, 16, 17, 21, 22, 23, 31, 36, 37,
38, 39, 41

Seroma: 14, 15, 16, 17, 18, 19, 36, 37, 38,
39

Silent Rupture: 12, 20, 21, 34, 42

Silicone: 10, 11, 12, 13, 20, 21, 22, 23, 24,
25, 26, 27, 28, 32, 33, 34, 42, 45, 47, 49

Subglandular Placement: 10, 28, 30

Submuscular Placement: 10, 28, 30

Suicide: 26, 27, 42, 43

Summary of Safety and Effectiveness
Document (SSED): 44

Surgical Incision: 13

Systemic Disease: 21

Toxic Shock Syndrome (TSS): 18

Warnings: 12

Wrinkling: 14, 15, 17, 20, 21, 22, 31, 36, 37,
38, 39, 40, 41

16. REFERENCES

1. Hölmich, L.R., et al. Prevalence of silicone breast implant rupture among Danish women. *Plast. Reconstr. Surg.* 108(4):848-858 (2001).
2. Collis, N., et al. Magnetic Resonance Imaging and Explantation Investigation of Long-Term Silicone Gel Implant Integrity. *Plast. Reconstr. Surg.* 120(5):1401-1406 (2007).
3. Gaubitz, M., Jackisch, C., Domschke, W., Heindel, W. & Pfeleiderer, B. Silicone breast implants: correlation between implant ruptures, magnetic resonance spectroscopically estimated silicone presence in the liver, antibody status and clinical symptoms. *Rheumatology (Oxford)* 41, 129-135; discussion 123-124 (2002).
4. Brown, S.L., Duggirala, H.J. & Pennello, G. An association of silicone-gel breast implant rupture and fibromyalgia. *Curr Rheumatol Rep* 4, 293-298 (2002).
5. Brown, S.L., Pennello, G., Berg, W.A., Soo, M. S. & Middleton, M.S. Silicone gel breast implant rupture, extracapsular silicone, and health status in a population of women. *J Rheumatol* 28, 996-1003 (2001).
6. Hölmich, L.R., et al. Self-reported diseases and symptoms by rupture status among unselected Danish women with cosmetic silicone breast implants. *Plast Reconstr Surg* 111, 723-732; discussion 733-724 (2003).
7. Katzin, W.E., Centeno, J.A., Feng, L. J., Kiley, M. & Mullick, F.G. Pathology of lymph nodes from patients with breast implants: a histologic and spectroscopic evaluation. *Am J Surg Pathol* 29, 506-511 (2005).
8. Berner, I., Gaubitz, M., Jackisch, C. & Pfeleiderer, B. Comparative examination of complaints of patients with breast-cancer with and without silicone implants. *Eur J Obstet Gynecol Reprod Biol* 102, 61-66 (2002).
9. Bondurant, S., Ernster, V.L. & Herdman, R. Safety of Silicone Breast Implants. Committee on the Safety of Silicone Breast Implants, Division of Health Promotion and Disease Prevention, Institute of Medicine. (National Academy Press., 2000).
10. Brown, S.L., Todd, J.F., Cope, J.U. & Sachs, H.C. Breast implant surveillance reports to the U.S. Food and Drug Administration: maternal-child health problems. *J Long Term Eff Med Implants* 16, 281-290 (2006).
11. Hurst, N.M. Lactation after augmentation mammoplasty. *Obstet. Gynecol.* 87(1):30-4 (1996).
12. American College of Obstetrics and Gynecology (ACOG). Breastfeeding: Maternal and Infant Aspects. Educational Bulletin Number 258 (July 2000).
13. Kronowitz, S.J. & Robb, G.L. Radiation therapy and breast reconstruction: a critical review of the literature. *Plast Reconstr Surg* 124, 395-408 (2009).
14. International Agency for Research on Cancer (IARC). Vol. 74 (IARC Press 1999).
15. European Committee on Quality Assurance (EQUAM) and Medical Devices in Plastic Surgery. Consensus declaration on breast implants 23- 6- 2000. Israel, European Committee on Quality Assurance (EQUAM). 4th Consensus Declaration (2000).
16. National Institutes of Health (NIH). Breast implants: Status of research at the National Institutes of Health (2005).
17. Herdman, R.C., et al. Silicone breast implants and cancer. *Cancer Invest.* 2001;19(8):821-32 (2001).
18. Brinton, L.A., et al. Breast cancer following augmentation mammoplasty (United States). *Cancer Causes Control* 11, 819-827 (2000).
19. Brisson, J., et al. Cancer incidence in a cohort of Ontario and Quebec women having bilateral breast augmentation. *Int J Cancer* 118, 2854-2862 (2006).
20. Deapen, D., Hamilton, A., Bernstein, L. & Brody, G.S. Breast cancer stage at diagnosis and survival among patients with prior breast implants. *Plast Reconstr Surg* 105, 535-540 (2000).
21. Deapen, D.M., Hirsch, E.M. & Brody, G.S. Cancer risk among Los Angeles women with cosmetic breast implants. *Plast Reconstr Surg* 119, 1987-1992 (2007).

22. Englert, H., et al. Women's health after plastic surgery. *Intern Med J* 31, 77-89 (2001).
23. Friis, S., et al. Cancer risk among Danish women with cosmetic breast implants. *Int J Cancer* 118, 998-1003 (2006).
24. Hölmich, L.R., et al. Stage of breast cancer at diagnosis among women with cosmetic breast implants. *Br J Cancer* 88, 832-838 (2003).
25. Jakub, J.W., et al. Breast cancer in patients with prior augmentation: presentation, stage, and lymphatic mapping. *Plast Reconstr Surg* 114, 1737-1742 (2004).
26. McLaughlin, J.K., et al. Long-term cancer risk among Swedish women with cosmetic breast implants: an update of a nationwide study. *J Natl Cancer Inst* 98, 557-560 (2006).
27. Mellemkjaer, L., et al. Cancer occurrence after cosmetic breast implantation in Denmark. *Int J Cancer* 88, 301-306 (2000).
28. Pukkala, E., et al. Incidence of breast and other cancers among Finnish women with cosmetic breast implants, 1970-1999. *J Long Term Eff Med Implants* 12, 271-279 (2002).
29. Brinton, L.A., Lubin, J.H., Murray, M.C., Colton, T. & Hoover, R.N. Mortality rates among augmentation mammoplasty patients: an update. *Epidemiology* 17, 162-169 (2006).
30. Jakubietz, M. G., Jeffrey, J., Jakubietz, R. & Rohrich, R.J. Breast augmentation: Cancer concerns and mammography - A literature review. *Plast. Reconstr. Surg.* 113, 117e-122e (2004).
31. Miglioretti, D.L., et al. Effect of breast augmentation on the accuracy of mammography and cancer characteristics. *Jama* 291, 442-450 (2004).
32. McLaughlin, J.K. and Lipworth, L. Brain cancer and cosmetic breast implants: A review of the epidemiological evidence. *Ann. Plast. Surg.* 52(2):15-17 (2004).
33. Brinton, L.A., et al. Cancer risk at sites other than the breast following augmentation mammoplasty. *Ann Epidemiol* 11, 248-256 (2001).
34. de Jong, D., et al. Anaplastic large-cell lymphoma in women with breast implants. *Jama* 300, 2030-2035 (2008).
35. Cook, L.S., et al. Characteristics of women with and without breast augmentation. *Jama* 277, 1612-1617 (1997).
36. Fryzek, J.P., et al. Characteristics of women with cosmetic breast augmentation surgery compared with breast reduction surgery patients and women in the general population of Sweden. *Ann Plast Surg* 45, 349-356 (2000).
37. Kjoller, K., et al. Characteristics of women with cosmetic breast implants compared with women with other types of cosmetic surgery and population-based controls in Denmark. *Ann Plast Surg* 50, 6-12, (2003).
38. Breiting, V.B., et al. Long-term health status of Danish women with silicone breast implants. *Plast Reconstr Surg* 114, 217-226; discussion 227-218 (2004).
39. Fryzek, J.P., et al. Self-reported symptoms among women after cosmetic breast implant and breast reduction surgery. *Plast. Reconstr. Surg.* 107:206-13 (2001).
40. Kjoller, K., et al. Self-reported musculoskeletal symptoms among Danish women with cosmetic breast implants. *Ann Plast Surg.* 52(1):1-7 (2004).
41. Blackburn, W.D., Jr. & Everson, M.P. Silicone-associated rheumatic disease: an unsupported myth. *Plast Reconstr Surg* 99, 1362-1367 (1997).
42. Brinton, L.A., et al. Risk of connective tissue disorders among breast implant patients. *Am J Epidemiol* 160, 619-627 (2004).
43. Fryzek, J.P., et al. A nationwide study of connective tissue disease and other rheumatic conditions among Danish women with long-term cosmetic breast implantation. *Ann Epidemiol* 17, 374-379 (2007).

44. Greenland, S. & Finkle, W.D. A retrospective cohort study of implanted medical devices and selected chronic diseases in Medicare claims data. *Ann Epidemiol* 10, 205-213 (2000).
45. Hochberg, M.C. & Perlmutter, D.L. The association of augmentation mammoplasty with connective tissue disease, including systematic sclerosis (scleroderma): a meta-analysis. *Curr Top Microbiol Immunol* 210, 411-417 (1996).
46. Janowsky, E.C., Kupper, L.L. & Hulka, B.S. Meta-analyses of the relation between silicone breast implants and the risk of connective-tissue diseases. *N Engl J Med* 342, 781-790 (2000).
47. Kjoller, K., et al. Connective tissue disease and other rheumatic conditions following cosmetic breast implantation in Denmark. *Arch Intern Med* 161, 973-979 (2001).
48. Lamm, S.H. Silicone breast implants, breast cancer and specific connective tissue diseases: A systematic review of the data in the epidemiological literature. *Int. J. Toxicol.* 17, 497-457 (1998).
49. Lewin, S.L. & Miller, T.A. A review of epidemiologic studies analyzing the relationship between breast implants and connective tissue diseases. *Plast Reconstr Surg* 100, 1309-1313 (1997).
50. Silverman, B.G., et al. Reported complications of silicone gel breast implants: an epidemiologic review. *Ann Intern Med* 124, 744-756 (1996).
51. Vermeulen, R.C. & Scholte, H.R. Rupture of silicone gel breast implants and symptoms of pain and fatigue. *J Rheumatol* 30, 2263-2267 (2003).
52. Wolfe, F. & Anderson, J. Silicone filled breast implants and the risk of fibromyalgia and rheumatoid arthritis. *J Rheumatol* 26, 2025-2028 (1999).
53. Wong, O. A critical assessment of the relationship between silicone breast implants and connective tissue diseases. *Regul Toxicol Pharmacol* 23, 74-85 (1996).
54. Lipworth, L., et al. Silicone breast implants and connective tissue disease: no association. *Semin. Immunopathol.* 33(3):287-294 (2011).
55. Independent Review Group (IRG). Silicone Gel Breast Implants: Report of the IRG (United Kingdom) (1998).
56. Tugwell, P., et al. Do silicone breast implants cause rheumatologic disorders? A systematic review for a court-appointed national science panel. *Arthritis Rheum* 44, 2477-2484 (2001).
57. Lugowski, S.J., et al. Analysis of silicon in human tissues with special reference to silicone breast implants. *J Trace Elem Med Biol* 14, 31-42 (2000).
58. Kjoller, K., et al. Health outcomes in offspring of Danish mothers with cosmetic breast implants. *Ann Plast Surg* 48, 238-245 (2002).
59. Signorello, L.B., Fryzek, J.P., Blot, W.J., McLaughlin, J.K. & Nyren, O. Offspring health risk after cosmetic breast implantation in Sweden. *Ann Plast Surg* 46, 279-286 (2001).
60. Hemminki, E., Hovi, S.L., Sevon, T. & Asko-Seljavaara, S. Births and perinatal health of infants among women who have had silicone breast implantation in Finland, 1967-2000. *Acta Obstet Gynecol Scand* 83, 1135-1140 (2004).
61. Jacobsen, P.H., et al. Mortality and suicide among Danish women with cosmetic breast implants. *Arch Intern Med* 164, 2450-2455 (2004).
62. Koot, V.C., Peeters, P.H., Granath, F., Grobbee, D.E. & Nyren, O. Total and cause specific mortality among Swedish women with cosmetic breast implants: prospective study. *BMJ* 326, 527-528 (2003).
63. Le, G.M., et al. Breast implants following mastectomy in women with early-stage breast cancer: prevalence and impact on survival. *Breast Cancer Res* 7, R184-193 (2005).

64. Lipworth, L., et al. Excess mortality from suicide and other external causes of death among women with cosmetic breast implants. *Ann Plast Surg* 59, 119-123; discussion 124-115 (2007).
65. McLaughlin, J.K., Lipworth, L. & Tarone, R.E. Suicide among women with cosmetic breast implants: a review of the epidemiologic evidence. *J Long Term Eff Med Implants* 13, 445-450 (2003).
66. Pukkala, E., et al. Causes of death among Finnish women with cosmetic breast implants, 1971-2001. *Ann Plast Surg* 51, 339-342; discussion 343-334 (2003).
67. Villeneuve, P.J., et al. Mortality among Canadian women with cosmetic breast implants. *Am J Epidemiol* 164, 334-341 (2006).
68. Klesmer, J. Mortality in Swedish women with cosmetic breast implants: body dysmorphic disorder should be considered. *BMJ* 326, 1266-1267 (2003).
69. Winther, J.F., et al. Neurological disease among women with silicone breast implants in Denmark. *Acta Neurol Scand* 103, 93-96 (2001).
70. Flassbeck, D., et al. Determination of siloxanes, silicon, and platinum in tissues of women with silicone gel-filled implants. *Anal Bioanal Chem* 375, 356-362 (2003).
71. Chandra, G., Lo, P.Y., Hitchcock, P. & Lappert, M.F. A convenient and novel route to bis(alkyne)platinum (0) and other platinum(0) complexes from Speier's hydrosilylation catalyst. *Organometallics*, 191-192 (1987).
72. Lappert, M.F. & Scott, F.P. A. The reaction pathway from Speier's to Karstedt's hydrosilylation catalyst. *J. Organomet. Chem.* 492, C11-C13 (1995).
73. Lewis, L.N., et al. Mechanism of Formation of Platinum (0) Complexes Containing Silicon-Vinyl Ligands. *Organometallics* 14, 2202-2213 (1995).
74. Stein, J. In situ determination of the active catalyst in hydrosilylation reactions using highly reactive Pt(0) catalyst precursors. *J. Am. Chem. Soc.* 121, 3693-3703 (1999).
75. FDA. FDA Update on the Safety of Silicone Gel-Filled Breast Implants. (June 2011).
76. Henriksen, T.F., et al. Surgical intervention and capsular contracture after breast augmentation: a prospective study of risk factors. *Ann Plast Surg* 54, 343-351 (2005).
77. Kulmala, I., et al. Local complications after cosmetic breast implant surgery in Finland. *Ann Plast Surg* 53, 413-419 (2004).
78. Hölmich, L.R., et al. Untreated silicone breast implant rupture. *Plast. Reconstr. Surg.* 114:204-214 (2004).
79. Balk, E.M., et al. 2015. Long-term health outcomes in women with silicone gel breast implants: a systematic review. Doi:10.7326/M15-1169 [Epub ahead of print].

This page is intentionally left blank.

This page is intentionally left blank.

IFU PRINTING SPECIFICATION SHEET

PAGE LAYOUT

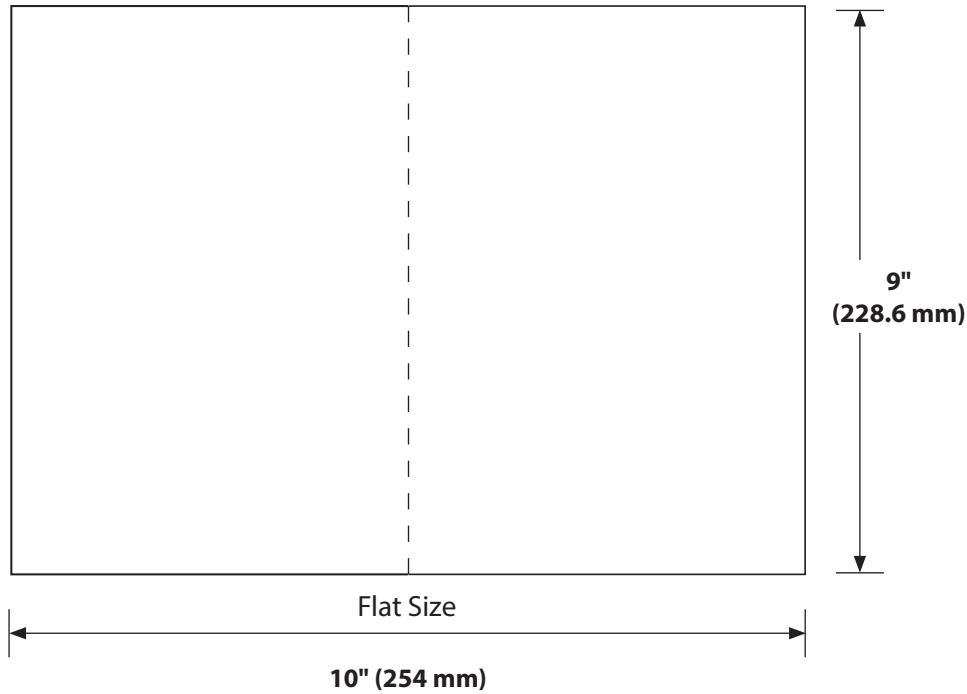

FOLD PATTERN

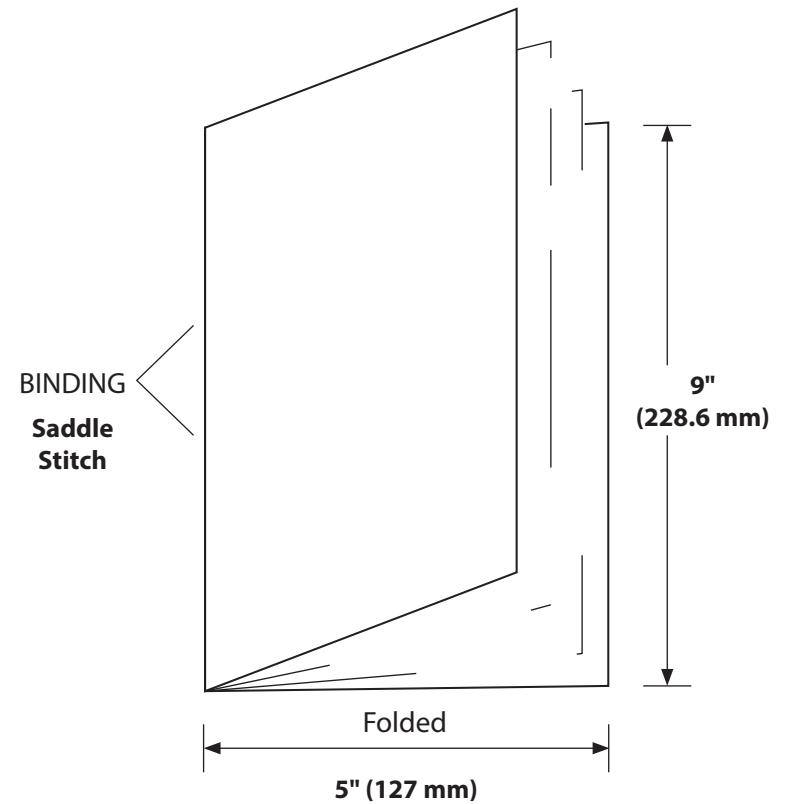

TITLE MENTOR® MemoryGel™ Augmentation		DESCRIPTION Patient Brochure		LAB NUMBER LAB100524216v2		SPECIAL INSTRUCTIONS/COMMENTS Perforation on pages 49-52		BINDING Saddle Stitch		COLORS CMYK		
FLAT SIZE 10" x 9" 254 mm x 228.6 mm		FOLDED SIZE 5" x 9" 127 mm x 228.6 mm		RMC NUMBER 112025-001 Rev B	PAGE COUNT 4 Cover, 60 Text; 64 total	LANGUAGES en			SELF COVER <input type="checkbox"/>	PLUS COVER <input checked="" type="checkbox"/>	SEALING METHOD n/a	WAFER SEAL <input type="checkbox"/>
BLEED SIZE <input type="checkbox"/> .5" (12.7 mm) <input checked="" type="checkbox"/> .125" (3.175 mm)		NONE <input type="checkbox"/>	BLEED ALL SIDES <input checked="" type="checkbox"/>	BLEED TOP <input type="checkbox"/>	BLEED RIGHT <input type="checkbox"/>	BLEED LEFT <input type="checkbox"/>	BLEED BOTTOM <input type="checkbox"/>		DRAWING IS NOT TO SCALE: DRAWINGS REFLECT INFORMATION FOR PRODUCTION OF PRINTED PIECES AND DO NOT CONTAIN ACTUAL ARTWORK. This document or data herein or herewith is not to be reproduced, used or disclosed in whole or part without the permission of Ethicon, Inc.			
STOCK Cover: 80# Cover; Text: 50# White Offset						ETHICON						