

Product Insert Data Sheet

---

**MENTOR® MEMORYGEL™ AND MENTOR® MEMORYGEL™ XTRA  
SILICONE GEL BREAST IMPLANTS**

---

112024-001 Rev B LAB100524215v2 Effective October 2018

**Caution: Federal (U.S.A.) law restricts this device to sale by or on the order of  
a licensed healthcare practitioner.**



**STERILE**

This page is intentionally left blank.

---

**TABLE OF CONTENTS**

<b>INTRODUCTION.....</b>	<b>5</b>
DIRECTIONS TO THE PHYSICIAN.....	5
PATIENT COUNSELING INFORMATION.....	5
INFORMED DECISION.....	5
DEVICE TRACKING.....	6
<b>DEVICE DESCRIPTION.....</b>	<b>6</b>
PHYSICIAN TRAININGS.....	7
<b>INDICATIONS FOR USE.....</b>	<b>8</b>
<b>CONTRAINDICATIONS.....</b>	<b>8</b>
<b>WARNINGS.....</b>	<b>8</b>
AVOID IMPLANT DAMAGE DURING SURGERY AND OTHER MEDICAL PROCEDURES.....	8
MICROWAVE DIATHERMY.....	10
<b>PRECAUTIONS.....</b>	<b>10</b>
SPECIFIC POPULATIONS.....	10
SURGICAL PRECAUTIONS.....	10
Device Integrity.....	10
Surgical Technique.....	10
Implant Selection.....	11
Incision Site Selection.....	11
Implant Placement Selection.....	11
Maintaining Hemostasis/Avoiding Fluid Accumulation.....	12
Recording Procedure.....	12
Postoperative Care.....	12
Explantation.....	12
<b>INFORMATION TO BE DISCUSSED WITH THE PATIENT.....</b>	<b>12</b>
RUPTURE.....	13
EXPLANTATION.....	13
REOPERATION.....	13
INFECTION.....	13
BREAST EXAMINATION TECHNIQUES.....	14
MAMMOGRAPHY.....	14
LACTATION.....	14
AVOIDING DAMAGE DURING OTHER TREATMENT.....	14
SMOKING.....	14
RADIATION TO THE BREAST.....	15
INSURANCE COVERAGE.....	15
MENTAL HEALTH AND ELECTIVE SURGERY.....	15
LONG-TERM EFFECTS.....	15
<b>GENERAL ADVERSE EVENTS ASSOCIATED WITH BREAST IMPLANT SURGERY.....</b>	<b>15</b>
RUPTURE.....	16
CAPSULAR CONTRACTURE.....	17
REOPERATION.....	17
IMPLANT REMOVAL.....	18
PAIN.....	18
CHANGES IN NIPPLE AND BREAST SENSATION.....	18

INFECTION .....	18
HEMATOMA/SEROMA .....	18
UNSATISFACTORY RESULTS .....	19
BREASTFEEDING COMPLICATIONS .....	19
ADDITIONAL COMPLICATIONS .....	19
<b>OTHER REPORTED CONDITIONS .....</b>	<b>19</b>
CONNECTIVE TISSUE DISEASE (CTD) DIAGNOSES OR SYNDROMES .....	19
CTD SIGNS AND SYMPTOMS .....	20
CANCER .....	20
Breast Cancer .....	20
Brain Cancer .....	20
Respiratory/Lung Cancer .....	20
Reproductive System Cancers .....	20
Lympho-Hematopoietic Cancers .....	21
Anaplastic Large Cell Lymphoma (ALCL) .....	21
Other Cancers .....	22
NEUROLOGICAL DISEASE, SIGNS, AND SYMPTOMS .....	22
SUICIDE .....	22
EFFECTS ON CHILDREN .....	22
POTENTIAL HEALTH CONSEQUENCES OF GEL BLEED .....	22
<b>MENTOR® MEMORYGEL™ BREAST IMPLANT CORE STUDY .....</b>	<b>23</b>
STUDY DESIGN .....	23
PATIENT ACCOUNTING AND BASELINE DEMOGRAPHIC PROFILE .....	23
RUPTURE INFORMATION ON MENTOR® MEMORYGEL™ BREAST IMPLANTS .....	25
EFFECTIVENESS OUTCOMES .....	26
SAFETY OUTCOMES .....	28
MAIN REASONS FOR REOPERATION .....	32
MAIN REASONS FOR BREAST IMPLANT REMOVAL .....	36
OTHER CLINICAL DATA FINDINGS .....	40
CTD DIAGNOSES .....	40
CTD SIGNS AND SYMPTOMS .....	40
CANCER .....	40
LACTATION COMPLICATIONS .....	41
REPRODUCTION COMPLICATIONS .....	41
SUICIDE .....	41
<b>DEVICE IDENTIFICATION CARD .....</b>	<b>41</b>
<b>DEVICE RETRIEVAL EFFORTS .....</b>	<b>41</b>
<b>PRODUCT EVALUATION .....</b>	<b>42</b>
<b>HOW TO REPORT PROBLEMS WITH AN IMPLANT .....</b>	<b>42</b>
<b>RETURNED GOODS AUTHORIZATION .....</b>	<b>43</b>
U.S. CUSTOMERS .....	43
INTERNATIONAL CUSTOMERS .....	43
<b>PRODUCT REPLACEMENT POLICY AND ADVANTAGE LIMITED WARRANTIES .....</b>	<b>43</b>
<b>REFERENCES .....</b>	<b>44</b>

## **INTRODUCTION**

### **Directions to the Physician**

The information supplied in this physician labeling document is intended to provide an overview of essential information about Mentor's MemoryGel™ Breast Implants and MemoryGel™ Xtra Breast Implants, including a device description, the indications for use, contraindications, warnings, precautions, important factors to discuss with a patient, adverse events, other reported conditions, a summary of Mentor's MemoryGel™ Breast Implant Core Study results, device retrieval efforts, product evaluation, how to report problems with an implant, and returned goods authorization.

### **Patient Counseling Information**

You should review this document and patient labeling prior to counseling the patient about Mentor's MemoryGel™ Breast Implants or MemoryGel™ Xtra Breast Implants and breast implant surgery. MemoryGel™ Breast Implants and MemoryGel™ Xtra Breast Implants labeling materials are part of physician training, a requirement described below. Please familiarize yourself with the content of this document and resolve any questions or concerns prior to proceeding with use of the device. As with any surgical procedure, breast implantation is NOT without risks. Breast implantation is an elective procedure, and the patient must be well counseled and understand the risk/benefit relationship.

Before making the decision to proceed with surgery, the surgeon or a designated patient counselor should instruct the patient to read *Patient Educational Brochure: Breast Augmentation/Reconstruction with MENTOR® MemoryGel™ and MemoryGel™ Xtra Silicone Gel Breast Implants* (patient brochures), and discuss with the patient the warnings, contraindications, precautions, important factors to consider, complications, and the MENTOR® MemoryGel™ Breast Implant Core Study results presented in the patient brochure. You should advise the patient of the potential complications and that medical management of serious complications may include additional surgery and explantation.

Please refer to the INFORMATION TO BE DISCUSSED WITH THE PATIENT section of this document for additional patient counseling information.

### **Informed Decision**

Each patient should receive Mentor's *Patient Educational Brochure: Breast Augmentation/Reconstruction with MENTOR® MemoryGel™ and MemoryGel™ Xtra Silicone Gel Breast Implants* during her initial visit/consultation to allow her sufficient time to read and adequately understand the important information on the risks, follow-up recommendations, and benefits associated with silicone gel breast implant surgery.

Allow the patient at least 1 to 2 weeks to review and consider this information before deciding whether to have primary breast augmentation surgery. In the case of a revision-augmentation, primary reconstruction, and revision-reconstruction, it may be medically advisable to perform surgery sooner.

In order to document a successful informed decision process, the patient brochure includes an ***Acknowledgment of Informed Decision*** form, which is to be signed by both the patient and the surgeon and then retained in the patient's file.

## Device Tracking

Silicone gel breast implants are subject to device tracking per Food and Drug Administration (FDA) regulation. Tracking is intended to facilitate notifying patients in the event that important new information about a device becomes available. The laws that govern device tracking require physicians to report certain information relating to their practice, the breast implants used, and the patients who receive breast implants (21 CFR §821.30)<sup>1</sup>. A physician prescribing MemoryGel™ Breast Implants or MemoryGel™ Xtra Breast Implants is required, by federal regulation, to comply with Device Tracking Regulations, and report to Mentor:

- The serial number of the implanted device(s),
- The date of the implant surgery,
- Patient's name,
- The patient's personal contact information (including address, telephone number and date of birth),
- Contact information for the prescribing physician's practice and the physician who regularly sees the patient for primary care, and
- (When applicable) the date the device was:
  - Explanted, with the name, mailing address, and telephone number of the explanting physician;
  - Out of use due to patient death (date of death);
  - Returned to the manufacturer;
  - Permanently disposed of.

Tracking continues until the implant is returned, destroyed, explanted, or the patient becomes deceased. Tracking information will be recorded on the Device Tracking Form supplied by Mentor with each implant. The form should then be returned to Mentor by fax or submitted via [www.MentorDirect.com](http://www.MentorDirect.com).

Mentor strongly recommends that all patients receiving MemoryGel™ silicone gel breast implants participate in Mentor's Device Tracking program.

Patients are not required by law to enroll themselves in any tracking program or device registry. However, if a patient declines to provide personal, identifying information, you must still provide all other non-patient specific information.

## DEVICE DESCRIPTION

MENTOR® MemoryGel™ Breast Implants and MENTOR® MemoryGel™ Xtra Breast Implants are round devices with shells constructed from medical grade silicone elastomer. The shell is filled with MemoryGel™, Mentor's proprietary formulation of medical grade silicone gel, and is constructed of successive cross-linked layers of silicone elastomer. There are two styles of shell: smooth and textured. In general, MENTOR® MemoryGel™ Xtra Breast Implants have a higher fill than MENTOR® MemoryGel™ Breast Implants. All implants, MemoryGel™ and MemoryGel™ Xtra are provided sterile.

## Physician Trainings

A surgeon must have completed Mentor's Device Access Education Course, which consists of training modules specific to these products and breast implant surgery, and provided Mentor with a Certificate of Completion, prior to receiving Mentor's MemoryGel™ Breast Implants or MemoryGel™ Xtra Breast Implants.

The following lists the catalog numbers and styles for MENTOR® MemoryGel™ Breast Implants and MENTOR® MemoryGel™ Xtra Breast Implants:

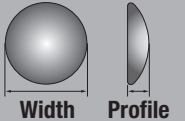
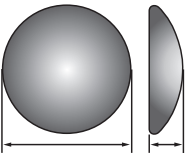
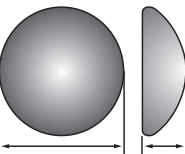
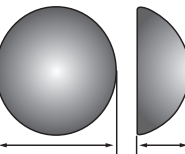
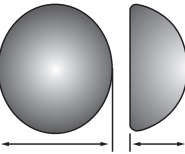
 Width    Profile	<b>MemoryGel™</b> <b>Breast Implant Description</b> <b>Catalog Number</b>	<b>Width (W)</b> <b>Profile Projection (P)</b>	<b>Size</b> <b>Range</b>
	<b>Moderate Profile</b> smooth shell surface: 350-7100BC/7800BC  textured shell surface: 354-1007/8007  <b>Moderate Classic Profile</b> smooth shell surface: 350-7130MC/7800MC  textured shell surface: 354-1307MC/8007MC	W: 9.3–18.2 cm P: 2.1–4.1 cm  W: 8.8–17.2 cm P: 2.5–4.6 cm  W: 9.6–18.0 cm P: 2.4–4.1 cm  W: 9.6–17.6 cm P: 2.5–4.4 cm	100–800 cc  100–800 cc  130–800 cc  130–800 cc
	<b>Moderate Plus Profile</b> smooth shell surface: 350-1001BC/8001BC  textured shell surface: 354-1001/8001	W: 8.2–16.5 cm P: 2.7–5.1 cm  W: 8.1–16.6 cm P: 2.7–5.0 cm	100–800 cc  100–800 cc
	<b>High Profile</b> smooth shell surface: 350-1254BC/8004BC  textured shell surface: 354-4125/4800	W: 8.3–15.5 cm P: 3.5–6.0 cm  W: 8.4–15.4 cm P: 3.6–6.3 cm	125–800 cc  125–800 cc
	<b>Ultra High Profile</b> smooth shell surface: 350-5135BC/5800BC  textured shell surface: 354-5135/5700	W: 7.8–14.1 cm P: 4.1–6.7 cm  W: 8.0–13.4 cm P: 4.3–6.7 cm	135–800 cc  135–700 cc

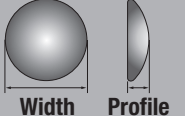
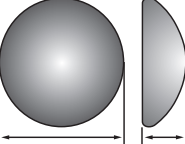
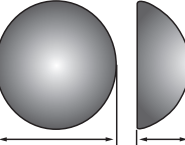
	<b>MemoryGel™ Xtra</b> <b>Breast Implant Description</b> <b>Catalog Number</b>	<b>Width (W)</b> <b>Profile Projection (P)</b>	<b>Size Range</b>
	<b>Moderate Plus Profile Xtra</b> smooth shell surface: SMPX-115/755  textured shell surface: TMPX-115/755	W: 8.3–15.7 cm P: 3.1–5.4 cm  W: 8.4–15.7 cm P: 3.1–5.6 cm	115–755 cc  115–755 cc
	<b>High Profile Xtra</b> smooth shell surface: SHPX-150/790  textured shell surface: THPX-150/765	W: 8.3–14.8 cm P: 4.1–6.7 cm  W: 8.4–14.7 cm P: 4.2–6.7 cm	150–790 cc  150–765 cc

## **INDICATIONS FOR USE**

*MENTOR® MemoryGel™ Breast Implants and MENTOR® MemoryGel™ Xtra Breast Implants are indicated for females for the following uses (procedures):*

- **Breast augmentation for women at least 22 years old.** Breast augmentation includes primary breast augmentation to increase the breast size, as well as revision surgery to correct or improve the result of a primary breast augmentation surgery.
- **Breast Reconstruction.** Breast reconstruction includes primary reconstruction to replace breast tissue that has been removed due to cancer or trauma or that has failed to develop properly due to a severe breast abnormality. Breast reconstruction also includes revision surgery to correct or improve the results of a primary breast reconstruction surgery.

## **CONTRAINDICATIONS**

*Patient Groups in which the product is contraindicated in women:*

- With active infection anywhere in their body.
- With existing cancer or pre-cancer who have not received adequate treatment for those conditions.
- Who are currently pregnant or nursing.

## **WARNINGS**

### **Avoid Implant Damage During Surgery and Other Medical Procedures**

iatrogenic events inadvertently induced by a physician or surgeon, or by medical treatment or procedures, may contribute to premature implant failure.



- 
- Do not allow cautery devices or sharp instruments, such as scalpels, suture needles, hypodermic needles, hemostats, Adson forceps or scissors to contact the device during the implantation or other surgical procedures. Patients should be instructed to inform other treating physicians to observe this warning.
  - The technique for inserting a gel device is significantly different than for a saline implant. Ensure that excessive force is not applied to a very small area of the shell during insertion of the device through the incision. Instead, apply force over as large an area of the implant as possible when inserting it. Avoid pushing the device into place with one or two fingers in a localized area, as this may create an area of weakness on the shell.
  - An incision should be of appropriate length to accommodate the style, size, and profile of the implant. The incision will be longer than the one typically made for a saline-filled breast implant. This will reduce the potential for creating excessive stress to the implant during insertion. In the Mentor clinical trials, the mean incision size was 4.4 centimeters for the round MemoryGel™ Breast Implants and 5.3 centimeters for the MemoryShape™ Breast Implants.
  - The anatomical limitations of periareolar and axillary incision sites may make insertion of the implant more difficult, increasing the risk of damage to the implant.
  - Avoid creating wrinkles or folds in the device during the implantation or other procedures (e.g., revision surgery). A typical practice is to run your finger around the implant before closing to ensure the implant is lying flat and has no folds or wrinkles. Submuscular placement of the device makes the inspection for wrinkles or folds more difficult.
  - Do not treat capsular contracture by closed capsulotomy or forceful external compression, which will likely result in implant damage, rupture, folds, and/or hematoma.
  - Use care in subsequent procedures such as open capsulotomy, breast pocket revision, hematoma/seroma aspiration, biopsy, and lumpectomy to avoid damage to the implant. Re-positioning of the implant during surgical procedures should be carefully evaluated by the medical team and care taken to avoid contamination of the implant. Use of excessive force during any subsequent procedure can contribute to localized weakening of the breast implant shell potentially leading to decreased device performance.
  - Do not immerse the implant in any liquid such as Betadine® or other iodine solution. If Betadine® is used in the pocket, ensure that it is rinsed thoroughly so no residual solution remains in the pocket.
  - Do not alter the implants or attempt to repair or insert a damaged implant.
  - Do not re-use or resterilize any product that has been previously implanted. Breast implants are intended for single use only. Re-use includes a risk of infection (microbial as well as viruses and transmissible agents) as well as immune responses. The sterility of the device can no longer be guaranteed. Furthermore, the integrity of the device cannot be guaranteed due to the risk of damage to the device. The established shelf life of the device is compromised and thus null and void if compliance with the single use only indication is not followed. Sterility, safety, and efficacy cannot be assured for damaged devices. In the event the product becomes contaminated, contact your local Mentor representative.
  - Do not place more than one implant per breast pocket.

- Do not use the periumbilical approach to place the implant.
- The use of surgical mesh together with the breast implant has not been studied in the Core study.

### **Microwave Diathermy**

Do not use microwave diathermy in patients with breast implants, as it has been reported to cause tissue necrosis, skin erosion, and implant extrusion.

## **PRECAUTIONS**

### **Specific Populations**

Safety and effectiveness has not been established in patients with:

- Autoimmune diseases (e.g., lupus and scleroderma),
- A weakened immune system (for example, currently taking drugs that weaken the body's natural resistance to disease),
- Planned chemotherapy following breast implant placement,
- Planned radiation therapy to the breast following breast implant placement,
- Conditions or medications that interfere with wound healing ability (e.g., poorly controlled diabetes or corticosteroid therapy) and/or blood clotting (such as concurrent Coumadin therapy),
- Reduced blood supply to breast or overlying tissue
- Clinical diagnosis of depression or other mental health disorders, including body dysmorphic disorder and eating disorders. Please discuss any history of mental health disorders with your patient prior to surgery. Patients with a diagnosis of depression or other mental health disorders should wait until resolution or stabilization of these conditions prior to undergoing breast implantation surgery.

There may be other patients with complicated medical histories who, in the surgeon's judgment, present risk factors for which breast implant safety and effectiveness have not been established. As with all surgery, you should review your patient's medical history to ensure that she is an appropriate candidate for breast implant surgery.

### **Surgical Precautions**

Surgical precautions, such as those described below, should be undertaken to maximize a successful aesthetic result and the long-term performance of the device.

***Device Integrity*** - The device should be tested for patency and shell integrity immediately prior to use. This can be accomplished by gently manipulating the prosthesis with hand and fingers, while carefully examining for rupture or leakage sites.

***Surgical Technique*** - The implantation of silicone gel breast implants involves a variety of surgical techniques. Therefore, the surgeon is advised to use the method which her/his own practice and discretion dictate to be best for the patient, consistent with this product insert data sheet. It is advisable to have

more than one size breast implant in the operating room at the time of surgery to allow for flexibility in determining the appropriate size implant to be used. A backup implant should also be available.

***Implant Selection*** - In order to properly select the correct implant, the following considerations should be taken into account and, as appropriate, discussed with the patient:

- The implant should be consistent in size with the patient's chest wall dimensions, including base width measurements, also considering the laxity of the tissue and the projection of the implant.
- A thorough discussion should be conducted with the patient, employing appropriate visual aids such as imaging, sizing implants, or other options to clarify her objectives and manage expectations, in order to reduce the incidence of reoperation for size change.
- The following may cause implants to be more palpable: textured implants, larger implants, subglandular placement, and an insufficient amount of skin/tissue available to cover the implant.
- Available tissue must provide adequate coverage of the implant.

### ***Incision Site Selection***

- The periareolar site is typically more concealed, but it may be associated with a higher likelihood of difficulties in successfully breastfeeding as compared to other incision sites.<sup>2</sup> A periareolar incision may result in changes in nipple sensation. As the incision for these implants will be longer than the one typically made for a saline or round silicone gel breast implant, the periareolar incision may not provide sufficient length in some patients.
- The inframammary incision is generally less concealed than the periareolar, but it may be associated with less breastfeeding difficulty than the periareolar incision site.<sup>2</sup>
- The axillary incision is less concealed than the periareolar site.
- The periumbilical approach has not been studied in Mentor's MemoryGel™ Breast Implant Core Study and should not be used for a wide variety of reasons, including potential damage to the implant shell.

### ***Implant Placement Selection***

- A well-defined, dry pocket of adequate size and symmetry must be created for implant placement.
- Submuscular placement may make surgery last longer, may make recovery longer, may be more painful, and may make it more difficult to perform some reoperation procedures than subglandular placement. The possible benefits of this placement are that it may result in less palpable implants, less likelihood of capsular contracture,<sup>3</sup> and easier imaging of the breast for mammography. Also, submuscular placement may be preferable if the patient has thin or weakened breast tissue.
- Subglandular placement may make surgery and recovery shorter, may be less painful, and may be easier to access for reoperation than the submuscular placement. However, this placement may result in more palpable implants, greater likelihood of capsular contracture,<sup>4,5</sup> and increased difficulty in imaging the breast with mammography.

**Maintaining Hemostasis/Avoiding Fluid Accumulation** - Careful hemostasis is important to prevent postoperative hematoma formation. Should excessive bleeding persist, implantation of the device should be delayed until bleeding is controlled. Postoperative evacuation of hematoma or seroma must be conducted with care to avoid breast implant contamination, or damage from sharp instruments, retraction, or needles.

**Recording Procedure** - Each breast implant is supplied with two Patient Record Labels showing the catalog number and lot number for that device. Patient Record Labels are located on the internal product packaging attached to the label. To complete the Patient ID Card, adhere one Patient Record Label for each implant on the back of the Patient ID Card. The other label should be affixed to the patient's chart. The implanted position (left or right side) should be indicated on the label. If a Patient Record Label is unavailable, the lot number, catalog number, and description of the device may be copied by hand from the device label. The patient should be provided with the Patient ID Card for personal reference.

**Postoperative Care** - You should advise your patient that she will likely feel tired and sore for several days following the operation, and that her breasts may remain swollen and sensitive to physical contact for a month or longer. You should also advise her that she may experience a feeling of tightness in the breast area as her skin adjusts to her new breast size. In order to avoid possible injury or damage to the incision site(s), you should advise your patients to avoid the following for the first month after the surgery:

- Sun exposure,
- Jerky movements or activities that stretch the skin at your incision site(s),
- Participating in sports or other activities that raise your pulse or blood pressure, and
- Unnecessary physical or emotional stress.

She should be able to return to work within a few days.

**Explantation** - If it is necessary to perform explantation of the implant, care must be taken to minimize manipulation of the product. Evaluation of the condition of the device upon explantation should be performed by the explanting surgeon and Mentor (refer to DEVICE RETRIEVAL EFFORTS and PRODUCT EVALUATION).

## **INFORMATION TO BE DISCUSSED WITH THE PATIENT**

Breast implantation is an elective procedure and the patient must be thoroughly counseled on the risks, as well as the benefits, of these products and procedures. You should advise your patient that she must read the patient brochures for either augmentation or reconstruction, as applicable. You must read the patient brochures in their entirety. The brochures are intended as the primary means to relate uniform risk and benefit information to assist your patient in making an informed decision about primary breast augmentation and revision-augmentation, or primary reconstruction and revision-reconstruction surgery (as applicable), but are not intended to replace consultation with you. The patient should be advised to wait 1 to 2 weeks after reviewing and considering this information, before deciding whether to have this surgery, unless an earlier surgery is deemed medically necessary.

Both you and your patient will be required to sign the “Acknowledgment of Informed Decision” form prior to surgery. The form can be found on the last page of each patient brochure. The form, once signed, acknowledges the patient’s full understanding of the information provided in the patient brochure. The form should be retained in the patient’s permanent clinical record.

Below are some of the important factors your patients need to be aware of when using silicone gel breast implants. Section 4 of the patient brochures provides a more detailed listing of important factors for patients.

### **Rupture**

Rupture of a silicone gel breast implant may be silent/asymptomatic (i.e., there are no symptoms experienced by the patient and no physical signs of changes with the implant), rather than symptomatic. You should advise your patient to undergo regular MRIs to screen for silent rupture even if she experiences no problems. The first MRI should be performed at 3 years postoperatively, then every 2 years, thereafter. The importance of these MRI evaluations should be emphasized. If rupture is noted on MRI, then you should advise your patient to have her implant removed. You should provide her with a list of MRI facilities in her area that have at least a 1.5 Tesla magnet, a dedicated breast coil, and a radiologist experienced with reading breast implant MRIs to diagnose a silent rupture. Diagnostic procedures will add to the cost of having implants, and patients should be aware or advised that these costs may exceed the cost of their initial surgery over their lifetime and that their insurance carrier may not cover these costs.

### **Explantation**

Implants are not considered lifetime devices, and patients likely will undergo implant removal(s), with or without replacement, over the course of their life. When implants are explanted without replacement, changes to the patient’s breasts may be irreversible. Complication rates are higher following revision surgery (removal with replacement).

### **Reoperation**

Additional surgeries to the patient’s breasts will likely be required, whether because of implant rupture, other complications, or unacceptable size/cosmetic outcomes. Patients should be advised that their risk of future complications increases with revision surgery as compared to primary augmentation or reconstruction surgery. Further, in a reoperation in which the implant is not removed (such as open capsulotomies or scar revision), there is a risk that the integrity of the implant’s shell could be compromised inadvertently, potentially leading to product failure.

### **Infection**

Signs of acute infection reported in association with breast implants include erythema, tenderness, fluid accumulation, pain, and fever. In rare instances, as with other invasive surgeries, Toxic Shock Syndrome (TSS) has been noted in women after breast implant surgery. It is a life-threatening condition. Symptoms of TSS occur suddenly and include a high fever (102°F, 38.8°C or higher), vomiting, diarrhea, a sunburn-like rash, red eyes, dizziness, lightheadedness, muscle aches, and drops in blood pressure, which may cause

fainting. Patients should be instructed to contact a doctor immediately for diagnosis and treatment if they have these symptoms.

### **Breast Examination Techniques**

Patients should perform breast self-examinations monthly and be shown how to distinguish the implant from their breast tissue. The patient should not manipulate or squeeze the implant excessively. The patient should be told that the presence of lumps, persistent pain, swelling, hardening, or change in the implant shape might be symptoms of rupture of the implant. If the patient has any of these signs, the patient should be told to report them to her surgeon, and possibly have an MRI evaluation to screen for rupture.

### **Mammography**

Patients should be instructed to undergo routine mammography exams as per their primary care physician's recommendations. The importance of having these exams should be emphasized. Patients should be instructed to inform their mammographers about the presence, type, and placement of their implants. Patients should have diagnostic mammography, rather than a screening mammography, because more pictures are taken with diagnostic mammography. Breast implants may complicate the interpretation of mammographic images by obscuring underlying breast tissue and/or by compressing overlying tissue. Accredited mammography centers, technicians with experience in imaging patients with breast implants, and use of displacement techniques are needed to adequately visualize breast tissue in the implanted breast. The current recommendations for preoperative or screening mammograms are no different for women with breast implants than for those women without implants. Presurgical mammography with a mammogram following the procedure may be performed to establish a baseline for routine future mammography in augmentation patients.

### **Lactation**

Breast implant surgery may interfere with the ability to successfully breastfeed, either by reducing or eliminating milk production. The Institute of Medicine (IOM), in its 1999 report on the safety of silicone breast implants, encourages mothers with silicone gel breast implants to breastfeed, stating that while breast implantation may increase the risk of lactation difficulties, there is no evidence of a hazard to the infant "beyond the loss of breastfeeding itself."<sup>3</sup> Other professional medical associations and independent scientific panels have echoed these conclusions and recommendations.<sup>6,7</sup>

### **Avoiding Damage During Other Treatment**

Patients should inform other treating physicians of the presence of implants to minimize the risk of damage to the implants.

### **Smoking**

As with any surgery, smoking may interfere with the healing process after breast implant surgery.

## **Radiation to the Breast**

Mentor has not tested the *in vivo* effects of radiation therapy in patients who have breast implants. The literature suggests that radiation therapy may increase the likelihood of capsular contracture,<sup>8,9</sup> necrosis, and implant extrusion.<sup>10</sup>

## **Insurance Coverage**

Patients should be advised that health insurance premiums may increase, insurance coverage may be dropped, and/or future coverage may be denied based on the presence of breast implants. Treatment of complications of breast implantation may not be covered as well. Patients should check with their insurance company regarding coverage issues before undergoing surgery.

## **Mental Health and Elective Surgery**

It is important that all patients seeking to undergo elective surgery have realistic expectations that focus on improvement rather than perfection. Request that your patient openly discuss with you, prior to surgery, any history that she may have of depression or other mental health disorders.

## **Long-Term Effects**

Mentor will continue its MemoryGel™ Breast Implant Core Study through the end of each patient's 10-year study term. In addition, Mentor has undertaken a separate 10-year post approval study in the U.S. and Canada to address specific issues for which the Mentor MemoryGel™ Breast Implant Core Study was not designed to fully answer, as well as to provide a real-world assessment of some endpoints. The endpoints in the MemoryGel™ Breast Implants post approval study include long-term local complications, connective tissue disease (CTD), CTD signs and symptoms, neurological disease, neurological signs and symptoms, offspring issues, reproductive issues, lactation issues, cancer, suicide, mammography issues, and MRI compliance and results. Mentor will update its labeling as appropriate with the results of its MemoryGel™ Breast Implant Core Study and separate post approval study. It is also important for you to relay any new safety information to your patients as it becomes available.

## **GENERAL ADVERSE EVENTS ASSOCIATED WITH BREAST IMPLANT SURGERY**

Potential adverse events that may occur with silicone gel breast implant surgery include: rupture, capsular contracture, reoperation, implant removal, pain, changes in nipple and breast sensation, infection, scarring, asymmetry, wrinkling, implant displacement/migration, implant palpability/visibility, breastfeeding complications, hematoma/seroma, implant extrusion, necrosis, delayed wound healing, breast tissue atrophy/ chest wall deformity, calcium deposits, lymphadenopathy, and additional complications.

Below is a description of these adverse events. For more specific adverse event rates/outcomes for MemoryGel™ Breast Implants, refer to the MENTOR® MEMORYGEL™ BREAST IMPLANT CORE STUDY section.

## Rupture

Breast implants are not lifetime devices. Breast implants rupture when the shell develops a tear or hole. Rupture can occur at any time after implantation, but it is more likely to occur the longer the implant is implanted. The following may cause implants to rupture: damage by surgical instruments; stressing the implant during implantation and weakening it; folding or wrinkling of the implant shell; excessive force to the chest (e.g., during closed capsulotomy, refer to WARNINGS); trauma; compression during mammographic imaging; and severe capsular contracture. Breast implants may also simply wear out over time.

Silicone gel implant ruptures are most often silent. (MRI examination is currently the best method to screen for silent rupture.) This means that most of the time neither you nor your patient will know if the implant has a tear or hole in the shell. This is why MRI is recommended at 3 years and then every 2 years, thereafter, to screen for rupture. Sometimes there are symptoms associated with gel implant rupture. These symptoms include hard knots or lumps surrounding the implant or in the armpit, change or loss of size or shape of the breast or breast implant, pain, tingling, swelling, numbness, burning, or hardening of the breast.<sup>11,12,13,14</sup>

When MRI findings of rupture are found (such as subcapsular lines, characteristic folded wavy lines, teardrop sign, keyhole sign, noose sign), or if there are signs or symptoms of rupture, you should remove the implant and any gel you determine your patient has, with or without replacement of the implant. It also may be necessary to remove the tissue capsule which will involve additional surgery, with associated costs. If your patient has symptoms, such as breast hardness, a change in breast shape or size, and/or breast pain, you should recommend that she has an MRI to determine whether rupture is present.<sup>3,15</sup>

There may also be consequences of rupture. If rupture occurs, silicone gel may either remain within the scar tissue capsule surrounding the implant (intracapsular rupture), move outside the capsule (extracapsular rupture), or gel may move beyond the breast (migrated gel). There is also a possibility that rupture may progress from intracapsular to extracapsular and beyond. There have been few health consequences associated with migrated gel reported in the literature.

Rupture rate information on Mentor's MemoryGel™ Breast Implants is provided in a published European study known as the U.K. Sharpe and Collis Study.<sup>16</sup> Silent rupture was assessed by MRI on 149 patients implanted with textured MemoryGel™ Breast Implants. The average age of the implants was approximately 10 years. The results suggest that by 13 years approximately 12% of implants will have ruptured. All ruptures were confirmed to be intracapsular. For more information on MemoryGel™ Breast Implants, refer to the MENTOR® MEMORYGEL™ BREAST IMPLANT CORE STUDY section of this brochure.

***Additional Information on Consequences of Rupture from Literature*** - Studies of Danish women evaluated with MRI involving a variety of manufacturers and implant models showed that about three-fourths of implant ruptures are intracapsular and the remaining one-fourth are extracapsular.<sup>17</sup> Additional studies of Danish women indicate that over a 2-year period, about 10% of the implants with intracapsular rupture progressed to extracapsular rupture as detected by MRI.<sup>15</sup> Approximately half of the women whose ruptures had progressed from intracapsular to extracapsular reported that they experienced trauma to the affected breast during this time period or had undergone mammography. In the other half, no cause was given. In the women with extracapsular rupture, after 2 years, the amount of silicone seepage outside the



scar tissue capsule increased for about 14% of these women. This type of information pertains to a variety of silicone gel implants from a variety of manufacturers and implant models, and is not specific to Mentor's implants.

Below is a summary of information related to the health consequences of implant rupture, which have not been fully established. These reports were in women who had implants from a variety of manufacturers and implant models.

- Local breast complications reported in the published literature that were associated with rupture include breast hardness, a change in breast shape or size, and breast pain.<sup>15</sup> These symptoms are not specific to rupture, as they also are experienced by women who have capsular contracture.
- There have been rare reports of gel movement to nearby tissues such as the chest wall, armpit, or upper abdominal wall, and to more distant locations down the arm or into the groin. This has led to nerve damage, granuloma formation, and/or breakdown of tissues in direct contact with the gel in a few cases. There have been reports of silicone presence in the liver of patients with silicone breast implants. Movement of silicone gel material to lymph nodes in the axilla also has been reported, even in women without evidence of rupture, leading to lymphadenopathy, as discussed below.<sup>18</sup>
- Concerns have been raised over whether ruptured implants are associated with the development of connective tissue or rheumatic diseases and/or symptoms such as fatigue and fibromyalgia.<sup>12,14,19,20</sup> A number of epidemiology studies have evaluated large populations of women with breast implants from a variety of manufacturers and implant models. These studies do not, taken together, support an association of breast implants and a diagnosed rheumatic disease. Other than one small study,<sup>14</sup> these studies do not distinguish whether the women had ruptured or intact implants.

### **Capsular Contracture**

Capsular contracture may be more common following infection, hematoma, and seroma, and the chance of it happening may increase over time. Capsular contracture occurs more commonly in patients undergoing revision surgery than in patients undergoing primary implantation surgery. Capsular contracture is a risk factor for implant rupture,<sup>3</sup> and it is one of the most common reasons for reoperation in augmentation and reconstruction patients. Symptoms of capsular contracture range from mild firmness and mild discomfort to severe pain, distorted shape of the implant, and palpability (ability to feel the implant).

Patients should also be advised that additional surgery may be needed in cases where pain and/or firmness are severe. This surgery ranges from removal of the implant capsule tissue to removal and possible replacement of the implant itself. This surgery may result in loss of breast tissue. Capsular contracture may happen again after these additional surgeries.

### **Reoperation**

Patients should be advised that additional surgery to their breast and/or implant will likely be necessary over the course of their life. Reoperations can be required for many reasons including a patient's decision to change the size or type of her implants, or to otherwise improve her breast surgery outcome.

## **Implant Removal**

Patients should be advised that the implants are not considered lifetime devices and they will potentially undergo implant removal, with or without replacement, over the course of their life. Patients should also be advised that the changes to their breast following explantation might be irreversible.

## **Pain**

Pain of varying intensity and length of time may occur and persist following breast implant surgery. In addition, improper size, placement, surgical technique, or capsular contracture may result in pain. Surgeons should instruct their patients to inform them if there is significant pain or if pain persists.

## **Changes in Nipple and Breast Sensation**

Sensation in the nipple and breast can increase or decrease after implant surgery. Sensation is typically lost after complete mastectomy where the nipple itself is removed. This loss of feeling can be severely lessened by partial mastectomy. Radiation therapy also can significantly reduce sensation in the remaining portions of the breast or chest wall. The placement of breast implants for reconstruction may further lessen the sensation in the remaining skin or breast tissue. The range of changes varies from intense sensitivity to no feeling in the nipple or breast following surgery. While some of these changes can be temporary, they can also be permanent, and may affect the patient's sexual response or ability to breastfeed.

## **Infection**

Infection can occur with any surgery or implant. Most infections resulting from surgery appear within a few days to weeks after the operation. However, infection is possible at any time after surgery. In addition, breast and nipple piercing procedures may increase the possibility of infection. Infections in tissue with an implant present are harder to treat than infections in tissue without an implant. If an infection does not respond to antibiotics, the implant may have to be removed, and another implant may be placed after the infection is resolved. As with many other surgical procedures, in rare instances, Toxic Shock Syndrome (TSS) has been noted in women after breast implant surgery. It is a life-threatening condition. Symptoms of TSS occur suddenly and include a high fever (102°F, 38.8°C or higher), vomiting, diarrhea, a sunburn-like rash, red eyes, dizziness, lightheadedness, muscles aches, and/or drops in blood pressure, which may cause fainting. Patients should be instructed to contact a doctor immediately for diagnosis and treatment if they have these symptoms.

## **Hematoma/Seroma**

Hematoma is a collection of blood within the space around the implant, and a seroma is a build-up of fluid around the implant. Having a hematoma and/or seroma following surgery may result in infection and/or capsular contracture later on. Symptoms from a hematoma or seroma may include swelling, pain, and bruising. If a hematoma or seroma occurs, it will usually be soon after surgery. However, this can also occur at any time after injury to the breast. While the body absorbs small hematomas and seromas, some will require surgery, typically involving draining and potentially placing a surgical drain in the wound temporarily for proper healing. A small scar can result from surgical draining. Implant rupture also can occur from surgical draining if there is damage to the implant during the draining procedure.

## **Unsatisfactory Results**

Patients should be informed that dissatisfaction with cosmetic results related to such things as incorrect size, scar deformity, hypertrophic scarring, capsular contracture, asymmetry, wrinkling, implant displacement/migration, and implant palpability/visibility might occur. Careful surgical planning or technique can minimize, but not preclude, the risk of such results. Pre-existing asymmetry may not be entirely correctable. Revision surgery may be indicated to maintain patient satisfaction but carries additional considerations and risks.

## **Breastfeeding Complications**

Breastfeeding difficulties have been reported following breast surgery, including breast reduction and breast augmentation. A periareolar surgical approach may further increase the chance of breastfeeding difficulties.

## **Additional Complications**

After breast implant surgery, the following may occur and/or persist, with varying intensity and/or varying length of time: implant extrusion, necrosis, delayed wound healing, and breast tissue atrophy/chest wall deformity. Calcium deposits can form in the tissue capsule surrounding the implant with symptoms that may include pain and firmness. Lymphadenopathy has also been reported in some women with implants.

## **OTHER REPORTED CONDITIONS**

There have been reports in the literature of other conditions in women with silicone gel breast implants. Many of these conditions have been studied to evaluate their potential association with breast implants. No cause and effect relationship has been established between breast implants and the conditions listed below. Furthermore, there is the possibility of risks, yet unknown, which in the future could be determined to be associated with breast implants. It should also be noted that the cited references include data from augmentation and/or reconstruction patients, as well as from a variety of manufacturers and implant models.

## **Connective Tissue Disease (CTD) Diagnoses or Syndromes**

Connective tissue diseases include diseases such as lupus, scleroderma, rheumatoid arthritis, and fibromyalgia. There have been a number of published epidemiological studies, meta-analyses, and “weight-of-the-evidence” or critical reviews that have looked at whether having a breast implant is associated with having a typical or defined connective tissue disease. The study size needed to conclusively rule out a smaller risk of connective tissue disease among women with silicone gel breast implants would need to be very large.<sup>3,12,14,20,21,22,23,24,25,26</sup> The published studies taken together show that breast implants are not significantly associated with a risk of developing a typical or defined connective tissue disease.<sup>3,22,23,24</sup> These studies do not distinguish between women with intact and ruptured implants. Only one study evaluated specific connective tissue disease diagnoses and symptoms in women with silent ruptured versus intact implants, but it was too small to rule out a small risk.<sup>14</sup> Another study in a small group of women concluded that significantly more women with ruptured implants than intact implants reported debilitating chronic fatigue;<sup>27</sup> the women reported their symptoms after learning whether or not they had a ruptured implant.

Independent scientific panels and review groups have also concluded that there is no evidence to support an association between breast implants and connective tissue disease, or at least, if a risk cannot be absolutely excluded it is too small to be quantified.<sup>3,7,24</sup> A recently published systematic review reported there is limited or suggestive evidence of an association between breast implants and rheumatoid arthritis.<sup>61</sup>

## **CTD Signs and Symptoms**

Literature reports have also been made associating silicone breast implants with various rheumatological signs and symptoms such as fatigue, exhaustion, joint pain and swelling, muscle pain and cramping, tingling, numbness, weakness, and skin rashes. Having these rheumatological signs and symptoms does not necessarily mean that a patient has a connective tissue disease. Scientific expert panels and literature reports have found no evidence of a consistent pattern of signs and symptoms in women with silicone gel breast implants.<sup>3,19,28,29,30</sup> If a patient has an increase in these signs or symptoms, you should refer your patient to a rheumatologist to determine whether these signs or symptoms are due to a connective tissue disorder or autoimmune disease.

## **Cancer**

**Breast Cancer** - Reports in the medical literature indicate that patients with breast implants are not at a greater risk than those without breast implants for developing breast cancer.<sup>31,32,33,34,35</sup> Some reports have suggested that breast implants may interfere with or delay breast cancer detection by mammography and/or biopsy; however, other reports in the published medical literature indicate that breast implants neither significantly delay breast cancer detection nor adversely affect cancer survival of women with breast implants.<sup>31,35,36,37,38,39,40</sup>

**Brain Cancer** - One study has reported an increased incidence of brain cancer in women with breast implants as compared to the general population.<sup>41</sup> The incidence of brain cancer, however, was not significantly increased in women with breast implants when compared to women who had other plastic surgeries; the study relied on very few cases and the authors relied upon death certificates for brain cancer diagnoses, which may reflect other cancers that have metastasized. Other recent large studies and a published review of four large studies in women with cosmetic implants concluded that the evidence does not support an association between brain cancer and breast implants.<sup>33,35,42,43,44,45,46</sup>

**Respiratory/Lung Cancer** - One study has reported an increased incidence of respiratory/lung cancer in women with breast implants.<sup>41</sup> Other studies of women in Sweden and Denmark have found that women who get breast implants are more likely to be current smokers than women who get breast reduction surgery or other types of cosmetic surgery.<sup>47,48,49</sup> Several large studies have found no association between breast implants and respiratory/lung cancer.<sup>33,35,43,44,46</sup> A recently published systematic review reported there is limited or suggestive evidence of an association between breast implants and lung cancer.<sup>61</sup>

**Reproductive System Cancers** - One study has reported an increased incidence of cervical/vulvar cancer in women with breast implants.<sup>41</sup> The cause of this increase is unknown. However, there was no increased risk when compared to women who had other types of plastic surgery. Another study reported an increased incidence of vulvar cancer that has not been explained.<sup>33</sup> Other recent large studies concluded

that the evidence does not support an association between reproductive system cancers and breast implants.<sup>35,42,43,44,45,46</sup>

***Lympho-Hematopoietic Cancers*** - One study has reported an increased risk of leukemia in women with breast implants as compared to the general population.<sup>41</sup> However, there was no increased risk when compared to women who had other types of plastic surgery. Other recent large studies concluded that the evidence does not support an association between lympho-hematopoietic cancers and breast implants.<sup>33,35,42,43,44,45,46</sup>

***Anaplastic Large Cell Lymphoma (ALCL)*** - Based on information reported to global regulatory agencies and found in medical literature, an association has been identified between breast implants and the development of anaplastic large cell lymphoma (ALCL), a type of non-Hodgkin's lymphoma. Women with breast implants have a very small but increased risk of developing Breast Implant Associated ALCL (BIA-ALCL) in the fluid or scar capsule adjacent to the implant, with documented potential for local, regional, and distant spread of the cancer with mortality reported in rare cases.

BIA-ALCL has been reported globally in patients with an implant history that includes Mentor's and other manufacturers' breast implants with various surface properties, styles, and shapes. Most of the cases in the literature reports describe a history of the use of textured implants. Several journal articles explore the risk factors for BIA-ALCL, including the methods used to create surface texture of the implant and the role of biofilm in causing disease, among others.

You should consider the possibility of BIA-ALCL when a patient presents with late onset, persistent peri-implant seroma. In some cases, patients presented with capsular contracture or masses adjacent to the breast implant. When testing for BIA-ALCL, collect fresh seroma fluid and representative portions of the capsule, and send to a laboratory with appropriate expertise for pathology tests to rule out ALCL, including immunohistochemistry testing for CD30 and ALK (anaplastic lymphoma kinase). If your patient is diagnosed with peri-implant BIA-ALCL, develop an individualized treatment plan in coordination with a multidisciplinary care team. Because of the small number of cases worldwide, there is no worldwide consensus on the treatment regimen for peri-implant BIA-ALCL. However, the National Comprehensive Cancer Network (NCCN) recommends surgical treatment that includes implant removal and complete capsulectomy ipsilaterally as well as contralaterally, where applicable.

Report all confirmed cases of BIA-ALCL to the FDA (<https://www.fda.gov/Safety/MedWatch>). In some cases, the FDA may contact you for additional information. The FDA will keep the identities of the reporter and the patient confidential.

FDA also recommends reporting cases of BIA-ALCL to the PROFILE Registry (<https://www.theptf.org/research/clinical-impact/profile.htm>) where you can submit more comprehensive case data. This will help provide a better understanding of the etiology of BIA-ALCL.

For additional information on FDA's analysis and review of BIA-ALCL, please visit:

**<https://www.fda.gov/MedicalDevices/ProductsandMedicalProcedures/ImplantsandProsthetics/BreastImplants/ucm239995.htm>**

**Other Cancers** - There have been several studies published that examined the risk of other types of cancers, (e.g., thyroid cancers, urinary system cancers, sarcoma, endocrine cancer, connective tissue cancer, cancer of the eye, and unspecified cancers in women with breast implants. All of those studies found no increased risk in women with breast implants.)<sup>14,28, 33,41,43,44,45,46</sup>

### **Neurological Disease, Signs, and Symptoms**

Some women with breast implants have complained of neurological symptoms (such as difficulties with vision, sensation, muscle strength, walking, balance, thinking or remembering things) or diseases (such as multiple sclerosis), which they believe are related to their implants. A scientific expert panel report found that the evidence for a neurological disease or syndrome caused by or associated with breast implants is insufficient or flawed.<sup>3</sup>

### **Suicide**

In several studies, a higher incidence of suicide was observed in women with breast implants.<sup>51,52,53,54</sup> The reason for the observed increase is unknown, but it was found that women with breast implants had higher rates of hospital admission due to psychiatric causes prior to surgery, as compared with women who had breast reduction or in the general population of Danish women.<sup>52</sup>

### **Effects on Children**

At this time, it is not known if a small amount of silicone may pass through the breast implant silicone shell into breast milk during breastfeeding. Although there are no current established methods for accurately detecting silicone levels in breast milk, a study measuring silicon (one component in silicone) levels did not indicate higher levels in breast milk from women with silicone gel breast implants when compared to women without implants.<sup>55</sup>

In addition, concerns have been raised regarding potential damaging effects on children born to mothers with implants. Two studies in humans have found that the risk of birth defects overall is not increased in children born after breast implant surgery.<sup>56,57</sup> Although low birth weight was reported in a third study, other factors (e.g., lower pre-pregnancy weight) may explain this finding.<sup>58</sup> This author recommended further research on infant health.

### **Potential Health Consequences of Gel Bleed**

Small quantities of low molecular weight (LMW) silicone compounds, as well as platinum (in zero oxidation state), have been found to diffuse (“bleed”) through an intact implant shell.<sup>3,59</sup> The evidence is mixed as to whether there are any clinical consequences associated with gel bleed. For instance, studies on implants implanted for a long duration have suggested that such bleed may be a contributing factor in the development of capsular contracture<sup>3</sup> and lymphadenopathy.<sup>18</sup> However, evidence against gel bleed being a significant contributing factor to capsular contracture and other local complications is provided by the fact that there are similar or lower complication rates for silicone gel breast implants than for saline-filled breast implants. Saline-filled breast implants do not contain silicone gel and, therefore, gel bleed is not an issue for those products. Furthermore, toxicology testing has indicated that the silicone material used in the Mentor implants does not cause toxic reactions when large amounts are administered to test animals. It should also be noted that studies reported in the literature have demonstrated that the low concentration of platinum contained

in breast implants is in the zero oxidation (most biocompatible) state.<sup>60</sup> In addition, two separate studies sponsored by Mentor have demonstrated that the low concentration of platinum contained in its breast implants is in the zero oxidation (most biocompatible) state.

Mentor performed a laboratory test to analyze the silicones and platinum (used in the manufacturing process), which may bleed out of intact MemoryGel™ Breast Implants into the body. The test method was developed to represent, as closely as possible, conditions in the body surrounding an intact implant. The results indicate that only the LMW silicones D4, D5, and D6, and platinum, bled into the serum in measurable quantities. In total, 4.7 micrograms of these 3 LMW silicones were detected. Platinum levels measured at 4.1 micrograms by 60 days, by which time an equilibrium level was reached and no more platinum was extracted from the device. Over 99% of the LMW silicones and platinum stayed in the implant. The overall body of available evidence supports that the extremely low level of gel bleed is of no clinical consequence.

### **MENTOR® MEMORYGEL™ BREAST IMPLANT CORE STUDY**

The safety and effectiveness of Mentor's round silicone gel implants were evaluated in an open-label multicenter clinical study, referred to as the MENTOR® MemoryGel™ Breast Implant Core Study. The information below provides more details about Mentor's MemoryGel™ Breast Implant Core Study and the complications and benefits your patients may experience.

#### **Study Design**

Mentor's MemoryGel™ Breast Implant Core Study is a 10-year study to assess safety and effectiveness in primary augmentation, primary reconstruction, and revision (augmentation and reconstruction) patients. The MemoryGel™ Breast Implant Core Study consists of 1,008 patients, including 552 primary augmentation patients, 145 revision-augmentation patients, 251 primary reconstruction patients, and 60 revision-reconstruction patients. Patients' medical histories were collected at baseline. Patient follow-up is at 10 weeks and annually through 10 years. MRI scans to detect silent rupture of the implant for a subset of patients are scheduled at 1, 2, 4, 6, 8, and 10 years. Safety assessments include complication rates and rates of reoperation. Effectiveness assessments include bra cup size change (primary augmentation patients only), circumferential chest size change, patient satisfaction, and quality of life (QoL) measures. The results through 6 years are reported in this document, and the study is currently ongoing. Mentor will periodically update this labeling as more information becomes available.

#### **Patient Accounting and Baseline Demographic Profile**

Mentor's MemoryGel™ Breast Implant Core Study consists of 1,008 patients, including 552 primary augmentation patients, 145 revision-augmentation patients, 251 primary reconstruction patients, and 60 revision-reconstruction patients. Data are available through 6 years post-implantation for 64% of the eligible primary augmentation patients, 70% of the eligible revision-augmentation patients, 79% of the eligible primary reconstruction patients, and 71% of the eligible revision-reconstruction patients.

Of the 1,008 patients in the study, 420 are in the MRI cohort, including 202 primary augmentation patients, 56 revision-augmentation patients, 134 primary reconstruction patients, and 28 revision-reconstruction

patients. Patients in the MRI cohort are assessed for silent rupture by MRI at years 1, 2, 4, 6, 8, and 10. MRI follow-up rates across indications were 38% (161 of 420 expected due), 78% (327 of 418 expected due), 67% (273 of 408 expected due), and 53% (217 of 406 expected due), at 1, 2, 4, and 6 years, respectively.

Demographic information for the MENTOR® MemoryGel™ Breast Implant Core Study are provided in Table 1.

**Table 1. MemoryGel™ Breast Implant Core Study Patient Demographics by Cohort**

Characteristic	Primary Augmentation N=552	Revision-Augmentation N=145	Primary Reconstruction N=251	Revision-Reconstruction N=60
<b>Age (years)</b>				
< 22	32 (5.8%)	2 (1.4%)	7 (2.8%)	0 (0%)
22-<25	40 (7.2%)	4 (2.8%)	4 (1.6%)	0 (0%)
25-<40	338 (61.2%)	51 (35.2%)	64 (25.5%)	7 (11.7%)
40-<50	118 (21.4%)	57 (39.3%)	97 (38.6%)	21 (35.0%)
50-<60	23 (4.2%)	29 (20.0%)	59 (23.5%)	23 (38.3%)
60-<70	1 (0.2%)	2 (1.4%)	17 (6.8%)	7 (11.7%)
70 & over	0 (0%)	0 (0%)	3 (1.2%)	2 (3.3%)
<b>Median Age</b>				
	34 years	43 years	46 years	51 years
<b>Marital Status</b>				
Never Married	135 (24.5%)	25 (17.2%)	35 (13.9%)	5 (8.3%)
Married	313 (56.7%)	86 (59.3%)	173 (68.9%)	40 (66.7%)
Separated	17 (3.1%)	3 (2.1%)	5 (2.0%)	1 (1.7%)
Divorced	81 (14.7%)	26 (17.9%)	30 (12.0%)	13 (21.7%)
Widower	6 (1.1%)	5 (3.4%)	8 (3.2%)	1 (1.7%)
<b>Race</b>				
Caucasian	483 (87.5%)	134 (92.4%)	231 (92.0%)	56 (93.3%)
African American	11 (2.0%)	2 (1.4%)	7 (2.8%)	2 (3.3%)
Asian	17 (3.1%)	2 (1.4%)	3 (1.2%)	1 (1.7%)
Other	41 (7.4%)	7 (4.8%)	10 (4.0%)	1 (1.7%)
<b>Education</b>				
Less than 12 Years	7 (1.3%)	0 (0%)	3 (1.2%)	2 (3.3%)
High School Graduate	74 (13.4%)	26 (17.9%)	42 (16.7%)	9 (15.0%)
Some College	215 (38.9%)	56 (38.6%)	66 (26.3%)	20 (33.3%)
College Graduate	189 (34.2%)	45 (31.0%)	85 (33.9%)	16 (26.7%)
Post-Graduate	60 (10.9%)	17 (11.7%)	47 (18.7%)	9 (15.0%)
Not Provided	7 (1.3%)	1 (0.7%)	8 (3.2%)	4 (6.7%)



In the MemoryGel™ Breast Implant Core Study, 1,898 devices (smooth and textured surface implants) were implanted in the 1,008 study patients, and Table 2 presents the surgical placement of these devices by study cohort.

**Table 2. Breast Implant Placement by Cohort**

<b>Implant Placement</b>	<b>Primary Augmentation N=1102</b>	<b>Revision-Augmentation N=287</b>
Submuscular/Subpectoral	730 (66.2%)	181 (63.1%)
Subglandular	372 (33.8%)	106 (36.9%)
Other	0 (0.0%)	0 (0.0%)
<b>Implant Placement</b>	<b>Primary Reconstruction N=410</b>	<b>Revision-Reconstruction N=99</b>
Submuscular/Subpectoral	358 (87.3%)	82 (82.8%)
Subglandular	42 (10.2%)	17 (17.2%)
Other	9 (2.2%)	0 (0.0%)
Missing	1 (0.2%)	0 (0.0%)

With respect to other surgical baseline factors in the MemoryGel™ Breast Implant Core Study, for both primary augmentation and revision-augmentation patients, the most common incision site was inframammary, while for primary reconstruction and revision-reconstruction patients, the most common incision site was the mastectomy scar.

### **Rupture Information on Mentor® MemoryGel™ Breast Implants**

In Mentor's MemoryGel™ Breast Implant Core Study, rupture was assessed for patients who had scheduled MRIs to screen for silent rupture (i.e., part of the MRI cohort). This population of patients was used as the basis for estimating the overall rupture rate because it is only in this sample that, in general, both silent ruptures and overt ruptures would have been detected. A total of 420 patients were enrolled in the MRI cohort, including 202 primary augmentation, 56 revision-augmentation, 134 primary reconstruction, and 28 revision-reconstruction patients.

MRI scans to detect silent rupture of the implant for the MRI cohort are scheduled at 1, 2, 4, 6, 8, and 10 years. At 1, 2, 4, and 6 years, the overall follow-up rates for the MRI cohort across all indications were 38% (161 of 420 expected due), 78% (327 of 418 expected due), 67% (273 of 408 expected due), and 53% (217 of 406 expected due), respectively. Based on the latest updated information, the estimated rupture rates through 6 years were 3.4% for primary augmentation, 7.2% for revision-augmentation, 8.1% for primary reconstruction, and 5.3% for revision-reconstruction. The estimated rupture rates through 1, 2, 4, and 6 years are presented in Table 3.

**Table 3. Cumulative Kaplan-Meier Adverse Event Risk Rates (95% Confidence Interval) for Rupture by Patient**

Cohort	1 Year % (95% CI)	2 Year % (95% CI)	4 Year % (95% CI)	6 Year % (95% CI)
Primary Augmentation, N=202	0	0	0.7 (0.1, 4.8)	3.4 (1.3, 8.7)
Revision-Augmentation, N=56	0	2.0 (0.3, 13.4)	4.3 (1.1, 16.3)	7.2 (2.4, 21.1)
Primary Reconstruction, N=134	0	0.9 (0.1, 5.9)	4.7 (2.0, 10.9)	8.1 (4.1, 15.5)
Revision-Reconstruction, N=28	0	0	0	5.3 (0.8, 31.9)

Overall, there have been 19 suspected or confirmed ruptured implants among 16 of the patients (4 primary augmentation, 3 revision-augmentation, 8 primary reconstruction, and 1 revision-augmentation) participating in the MRI cohort and 16 suspected or confirmed ruptured implants among 14 of the patients (2 primary augmentation, 1 revision-augmentation, 10 primary reconstruction, and 1 revision-reconstruction) participating in the non-MRI cohort. Of the 35 suspected or confirmed ruptured implants in the overall study, 4 cases were indeterminate for extracapsular silicone by MRI. There were no cases of migrated gel. The rupture rate beyond 6 years in Mentor's MemoryGel™ Breast Implant Core Study continues to be investigated.

Rupture rate information on Mentor's MemoryGel™ Breast Implants is also provided in a published European study known as the U.K. Sharpe and Collis Study.<sup>16</sup> Silent rupture was assessed by MRI on 149 patients implanted with textured MemoryGel™ Breast Implants. The average age of the implants was approximately 10 years. The results suggest that by 13 years approximately 12% of implants will have ruptured. All ruptures were confirmed to be intracapsular.

### Effectiveness Outcomes

The benefits of the implants were assessed by bra cup size change (augmentation patients only), circumferential chest size change, patient satisfaction, and quality of life (QoL) measures (self-worth, body image, self-concept, and physical, mental, and social health). Patient satisfaction in Mentor's MemoryGel™ Breast Implant Core Study was based on a single question of "Would the patient have this breast surgery again?" The QoL measures were the Rosenberg Self-Esteem Scale (measures self-worth or self-acceptance), the Body Esteem Scale (measures a person's body image), the Tennessee Self Concept Scale (TSCS; measures self-concept), the SF-36 (measures physical, mental, and social health), and the Functional Living Index of Cancer (cancer patients only). These outcomes were assessed before implantation and at 1, 2, 4, and 6 years after surgery for those patients who still had their original implants and came back for follow-up visits.

**Primary Augmentation Patients** - For primary augmentation patients, 311 (56%) out of the 552 patients enrolled were included in the analysis of cup size at 6 years. Of these 311 patients, 305 (98%) experienced at least one cup size increase. For circumferential chest size, 332 (60%) of the 552 patients enrolled were included in the analysis at 6 years. The average increase in circumferential chest size was 7.4 centimeters (2.9 inches).

At 6 years, 342 (62%) of the 552 patients enrolled answered the patient satisfaction question. Of these 342 patients, 336 (98%) stated to their surgeon that they would make the same decision to have breast surgery.

With regard to QoL measures at 6 years for primary augmentation patients, there was no significant change in the SF-36 or the total score of the TSCS. There was a significant increase in the total score and the positive attitude score for the Rosenberg Self Esteem Scale and the total score and chest and sexual attractiveness subscales for the Body Esteem Scale.

**Revision-Augmentation Patients** - For revision-augmentation patients, 87 (60%) out of the 145 patients enrolled were included in the circumferential chest size analysis at 6 years. The average increase in circumferential chest size was 3.2 centimeters (1.3 inches).

At 6 years, 90 (62%) of the 145 revision-augmentation patients enrolled answered the patient satisfaction question. Of these 90 patients, 89 (99%) stated to their surgeon that they would make the same decision to have breast surgery.

With regard to QoL measures at 6 years for revision-augmentation patients, there was a significant decrease in the Mental Component Score of the SF-36, indicating a negative effect of treatment. There was a significant increase in the chest score of the Body Esteem Scale and no significant changes in the Rosenberg Self Esteem scale. For the TSCS, there was a significant decrease, suggesting a lessening in self-concept as measured by this assessment.

**Primary Reconstruction Patients** - For primary reconstruction patients, 108 (43%) out of the 251 patients enrolled were included in the analysis of circumferential chest size at 6 years. The average increase in circumferential chest size was 3.8 centimeters (1.5 inches).

At 6 years, 126 (50%) of 251 primary reconstruction patients enrolled answered the patient satisfaction question. Of these 126 patients, 125 (99%) stated to their surgeon that they would make the same decision to have breast surgery.

With regard to QoL measures at 6 years for primary reconstruction patients, there was no significant change in the SF-36, Rosenberg Self Esteem Scale, or the total score of the TSCS. For the Body Esteem Scale, there was no significant change in the total score, but there was a significant increase in the chest scale and sexual attractiveness scores. For the Functional Living Index of Cancer, there was a significant increase.

**Revision-Reconstruction Patients** - For revision-reconstruction patients, 36 (60%) out of the 60 patients enrolled were included in the analysis of circumferential chest size at 6 years. The average increase in circumferential chest size was 2.1 centimeters (0.8 inches).

At 6 years, 40 (67%) out of 60 revision-reconstruction patients enrolled answered the patient satisfaction question. Of these 40 patients, 37 (93%) stated to their surgeon that they would make the same decision to have breast surgery.

With regard to QoL measures at 6 years for revision-reconstruction patients, there was a significant decrease in the Physical Component Score of the SF-36. There was no change observed on the Rosenberg Self Esteem Scale. For the Body Esteem Scale, there was a significant decrease for the total score and a significant increase for the chest scale score. There was a significant decrease in the TSCS, suggesting a lessening in self-concept as measured by this assessment.

## Safety Outcomes

Mentor's 10-year MemoryGel™ Breast Implant Core Study of 1,008 patients is continuing with the results through 6 years reported in Tables 4a-4d below. The rates reflect the estimated percentage of patients who will experience the listed complication at least once within the first 6 years after implantation. In Mentor's MemoryGel™ Breast Implant Core Study, some complications occurred more than once for some patients. Refer to Table 3 for more detailed estimated rupture rates. Note: Complications are defined as adverse events occurring in connection with the breast implant surgery, breast implants and/or the breast mound, and systemic diseases.

**Table 4a. Cumulative Kaplan-Meier Adverse Event Risk Rates (95% Confidence Interval), by Patient for Primary Augmentation Cohort, N=552**

Key Complications	Year 6 % (95% CI)
Capsular Contracture Baker Grade III, IV	9.8 (7.6, 12.7)
Infection	1.6 (0.9, 3.1)
Explantation with or without Replacement	6.7 (4.9, 9.2)
Explantation with Replacement with Study Device	3.7 (2.4, 5.7)
Any Reoperation	19.1 (16.1, 22.7)
Rupture (MRI Cohort) <sup>1</sup>	3.4 (1.3, 8.7)
<b>Other Complications ≥ 1%</b>	<b>% (95% CI)</b>
Nipple Sensation Changes <sup>2</sup>	11.8 (9.3, 14.8)
Capsular Contracture Baker Grade III	8.9 (6.8, 11.6)
Hypertrophic Scarring (irregular, raised scar)	6.8 (5.0, 9.2)
Ptosis (sagging)	5.7 (4.0, 8.0)
Breast Mass	4.7 (3.2, 6.9)
Miscarriage	3.1 (1.9, 5.0)
Hematoma	2.9 (1.8, 4.8)
Breast Sensation Changes <sup>2</sup>	2.8 (1.7, 4.5)
Capsular Contracture Baker Grade IV	2.5 (1.4, 4.2)
Breast Pain <sup>2</sup>	2.0 (1.1, 3.6)
Lactation Difficulties	2.0 (1.1, 3.6)
Capsular Contracture Baker Grade II with Surgical Intervention	1.5 (0.8, 3.0)
New Diagnosis of Rheumatic Disease <sup>3</sup>	1.3 (0.6, 2.8)
Seroma	1.1 (0.5, 2.5)
Wrinkling <sup>2</sup>	1.1 (0.5, 2.5)

<sup>1</sup> Rupture was assessed by MRI at 1, 2, 4, and 6 years (results provided in Table 3).

<sup>2</sup> Mild occurrences were excluded.

<sup>3</sup> There were 9 diagnoses for the 7 primary augmentation patients: carpal tunnel syndrome, chronic fatigue, fibromyalgia (2 cases), Hashimoto's thyroiditis, hypothyroidism, other inflammatory arthritis, systemic lupus erythematosus, and thyroiditis.

**Table 4b. Cumulative Kaplan-Meier Adverse Event Risk Rates (95% Confidence Interval), by Patient for Revision-Augmentation Cohort, N=145**

<b>Key Complications</b>	<b>Year 6 % (95% CI)</b>
Capsular Contracture Baker Grade III, IV	22.1 (16.1, 30.0)
Infection	1.4 (0.4, 5.5)
Explantation with or without Replacement	17.8 (12.4, 25.2)
Explantation with Replacement with Study Device	8.9 (5.1, 15.1)
Any Reoperation	33.1 (26.0, 41.6)
Rupture (MRI Cohort) <sup>1</sup>	7.2 (2.4, 21.1)
<b>Other Complications ≥ 1%</b>	<b>% (95% CI)</b>
Capsular Contracture Baker Grade III	20.7 (14.9, 28.4)
Nipple Sensation Changes <sup>2</sup>	12.9 (8.3, 19.7)
Hypertrophic Scarring (irregular, raised scar)	7.7 (4.3, 13.5)
Capsular Contracture Baker Grade IV	7.1 (3.9, 12.8)
Breast Mass	6.4 (3.4, 12.0)
Capsular Contracture Baker Grade II with Surgical Intervention	5.0 (2.4, 10.2)
Hematoma	2.8 (1.1, 7.2)
Miscarriage	2.4 (0.8, 7.4)
Granuloma	2.4 (0.8, 7.2)
Wrinkling <sup>2</sup>	2.2 (0.7, 6.8)
Ptosis (sagging)	2.2 (0.7, 6.7)
Delayed Wound Healing <sup>2</sup>	2.1 (0.7, 6.3)
Seroma	2.1 (0.7, 6.3)
New Diagnosis of Breast Cancer	1.8 (0.5, 6.9)
New Diagnosis of Rheumatic Disease <sup>3</sup>	1.6 (0.4, 6.3)
Lactation Difficulties	1.5 (0.4, 6.0)
Breast Pain <sup>2</sup>	1.4 (0.4, 5.5)
Extrusion	1.4 (0.4, 5.5)
Inflammation of Breast	1.4 (0.4, 5.5)
Implant Malposition/Displacement	1.4 (0.4, 5.4)
Breast Sensation Changes <sup>2</sup>	1.4 (0.4, 5.4)

<sup>1</sup> Rupture was assessed by MRI at 1, 2, 4, and 6 years (results provided in Table 3).

<sup>2</sup> Mild occurrences were excluded.

<sup>3</sup> There were 3 diagnoses for the 3 revision-augmentation patients: celiac disease, fibromyalgia, and rheumatoid arthritis.

**Table 4c. Cumulative Kaplan-Meier Adverse Event Risk Rates (95% Confidence Interval), by Patient for Primary Reconstruction Cohort, N=251**

<b>Key Complications</b>	<b>Year 6 % (95% CI)</b>
Capsular Contracture Baker Grade III, IV	12.8 (9.0, 17.9)
Infection	5.8 (3.5, 9.6)
Explantation with or without Replacement	17.3 (13.1, 22.7)
Explantation with Replacement with Study Device	8.9 (5.9, 13.3)
Any Reoperation	33.5 (27.9, 39.8)
Rupture (MRI Cohort) <sup>1</sup>	8.1 (4.1, 15.5)
<b>Other Complications ≥ 1%</b>	<b>% (95% CI)</b>
Capsular Contracture Baker Grade III	11.6 (8.0, 16.6)
Asymmetry <sup>2</sup>	6.9 (4.3, 11.0)
Ptosis (sagging)	6.4 (3.9, 10.7)
Metastatic Disease	6.1 (3.7, 10.2)
Hypertrophic Scarring (irregular, raised scar)	5.4 (3.2, 9.1)
Breast Mass	4.9 (2.8, 8.8)
Seroma	4.8 (2.8, 8.4)
Capsular Contracture Baker Grade II with Surgical Intervention	3.2 (1.5, 6.6)
Wrinkling <sup>2</sup>	3.0 (1.4, 6.2)
Miscarriage	2.8 (1.3, 6.2)
Capsular Contracture Baker Grade IV	2.7 (1.2, 6.0)
Nipple Sensation Changes <sup>2</sup>	2.5 (1.1, 5.5)
Breast Pain <sup>2</sup>	2.1 (0.9, 5.1)
Implant Malposition/Displacement	2.1 (0.9, 4.9)
New Diagnosis of Rheumatic Disease <sup>3</sup>	1.4 (0.5, 4.3)
New Diagnosis of Breast Cancer	1.4 (0.5, 4.3)
Nipple Complications <sup>2</sup>	1.3 (0.4, 4.1)
Hematoma	1.3 (0.4, 3.8)
Dog Ear Scars from Mastectomy	1.2 (0.4, 3.8)
Extrusion	1.2 (0.4, 3.7)

<sup>1</sup> Rupture was assessed by MRI at 1, 2, 4, and 6 years (results provided in Table 3).

<sup>2</sup> Mild occurrences were excluded.

<sup>3</sup> There were 5 diagnoses for the 3 primary reconstruction patients: chronic fatigue, cold urticaria, fibromyalgia (2 cases), and other inflammatory arthritis.

**Table 4d. Cumulative Kaplan-Meier Adverse Event Risk Rates (95% Confidence Interval), by Patient for Revision-Reconstruction Cohort, N=60**

<b>Key Complications</b>	<b>Year 6 % (95% CI)</b>
Capsular Contracture Baker Grade III, IV	21.1 (12.5, 34.2)
Infection	0.0
Explantation with or without Replacement	23.6 (14.7, 36.6)
Explantation with Replacement with Study Device	15.8 (8.5, 28.2)
Any Reoperation	33.5 (23.1, 47.0)
Rupture (MRI Cohort) <sup>1</sup>	5.3 (0.8, 31.9)
<b>Other Complications ≥ 1%</b>	<b>% (95% CI)</b>
Capsular Contracture Baker Grade III	19.1 (11.1, 32.0)
Asymmetry <sup>2</sup>	12.8 (6.3, 25.1)
Wrinkling <sup>2</sup>	8.9 (3.8, 20.1)
Breast Mass	7.2 (2.8, 18.2)
Implant Malposition/Displacement	6.7 (2.6, 16.9)
Lack of Projection	5.6 (1.8, 16.4)
New Diagnosis of Rheumatic Disease <sup>3</sup>	5.4 (1.8, 15.9)
Breast Pain <sup>2</sup>	5.2 (1.7, 15.3)
Granuloma	5.0 (1.6, 14.7)
Capsular Contracture Baker Grade IV	3.8 (1.0, 14.4)
Hematoma	3.4 (0.9, 13.0)
Ptosis (sagging)	3.4 (0.9, 13.0)
Symmastia	3.4 (0.9, 12.8)
Contracted Scar on Breast	2.1 (0.3, 14.2)
Scarring	2.0 (0.3, 13.1)
Breast Sensation Changes <sup>2</sup>	1.8 (0.3, 12.0)
Capsular Contracture Baker Grade II with Surgical Intervention	1.8 (0.3, 11.8)
Herniation of Areola and Breast	1.8 (0.3, 11.8)
Hypertrophic Scarring (irregular, raised scar)	1.8 (0.3, 11.8)
Dog Ear Scars from Mastectomy	1.7 (0.2, 11.4)
Inflammation of Breast	1.7 (0.2, 11.4)
Metastatic Disease	1.7 (0.2, 11.4)
New Diagnosis of Breast Cancer	1.7 (0.2, 11.4)
Skin Cyst on Breast	1.7 (0.2, 11.4)
Breast Trauma External Cause	1.7 (0.2, 11.3)

**Table 4d. Continued on next page**

**Table 4d. (Continued)**

<b>Other Complications <math>\geq</math> 1%</b>	<b>% (95% CI)</b>
Capsule Tear	1.7 (0.2, 11.3)
Delayed Wound Healing <sup>2</sup>	1.7 (0.2, 11.3)
Extrusion	1.7 (0.2, 11.3)
Nipple Sensation Changes <sup>2</sup>	1.7 (0.2, 11.3)
Patient Would Not Have Surgery Again	1.7 (0.2, 11.3)
Seroma	1.7 (0.2, 11.3)

<sup>1</sup> Rupture was assessed by MRI at 1, 2, 4, and 6 years (results provided in Table 3).

<sup>2</sup> Mild occurrences were excluded.

<sup>3</sup> There were 5 diagnoses for the 5 revision-reconstruction patients: fibromyalgia, other connective tissue disorder, other inflammatory arthritis (2 cases), and pyoderma gangrenosum.

The risk of a patient experiencing any complication (excluding rupture) at some point through 6 years after implant surgery was also calculated. Through 6 years, this risk was 44% for primary augmentation patients and 54% for revision-augmentation patients. This risk through 6 years was 52% for primary reconstruction patients and 57% for revision-reconstruction patients.

### **Main Reasons for Reoperation**

This section includes the main reasons for reoperation. The rates exclude planned secondary surgeries and reoperations for which the only reason for reoperation was staged reconstruction. Percentages are based upon the number of reoperations. If multiple procedures were performed on a patient on the same date, they are considered to constitute a single reoperation, regardless of whether one or both breasts were involved.

If a bilateral reoperation had different primary reasons for reoperation for the left and right breast implants, a hierarchy of reasons for reoperation was used in order to establish a primary reason for reoperation. In these cases, the following hierarchy was used: rupture, suspected rupture, capsular contracture Baker Grade III/IV, capsular contracture Baker Grade II, hematoma, surgical complications related to technique, breast pain, wrinkling, asymmetry, contralateral explant for symmetry due to rupture, ptosis, abnormal screening, implant removal – patient request, size change, and missing.

Through 6 years, there were 229 additional surgical procedures performed in 141 reoperations involving 104 primary-augmentation patients. The most common reason for reoperation through 6 years was capsular contracture III/IV (38 of 141 reoperations). Table 5a below provides the main reason for each reoperation following initial implantation through 6 years for primary augmentation patients.



**Table 5a. Main Reasons for Reoperation for Primary Augmentation Cohort**

<b>Primary Reason for Reoperation</b>	<b>Year 6 N=141 Reoperations<sup>1</sup> n (%)</b>
Capsular Contracture Baker Grade III/IV	38 (27.0)
Size Change	17 (12.1)
Hypertrophic Scarring	16 (11.3)
Breast Mass	13 (9.2)
Hematoma/Seroma	12 (8.5)
Asymmetry	6 (4.3)
Capsular Contracture Baker Grade II	6 (4.3)
Implant Malposition	4 (2.8)
Ptosis	4 (2.8)
Breast/Skin Lesions	4 (2.8)
Implant removal – patient request	3 (2.1)
Infection	3 (2.1)
Breast Pain	2 (1.4)
Calcification	2 (1.4)
Extrusion/Necrosis	2 (1.4)
Capsular Tear	1 (0.7)
Delayed Wound Healing	1 (0.7)
Drainage from Incision After Cat Scratched	1 (0.7)
Palpability	1 (0.7)
Previous Surgical Complication	1 (0.7)
Rupture	1 (0.7)
Suspected Rupture	1 (0.7)
Suture Complication	1 (0.7)
Wrinkling	1 (0.7)

<sup>1</sup> All reoperations were counted, with the primary reason for each reoperation presented.

Through 6 years, there were 135 additional surgical procedures performed in 72 reoperations involving 47 revision-augmentation patients. The most common reason for reoperation in revision-augmentation patients through 6 years was capsular contracture III/IV (20 of 72 reoperations). Table 5b below provides the main reason for each reoperation following initial implantation through 6 years for revision-augmentation patients.

**Table 5b. Main Reasons for Reoperation for Revision-Augmentation Cohort**

<b>Primary Reason for Reoperation</b>	<b>Year 6 N=72 Reoperations<sup>1</sup> n (%)</b>
Capsular Contracture Baker Grade III/IV	20 (27.8)
Breast Mass	9 (12.5)
Size Change	7 (9.7)
Capsular Contracture Baker Grade II	5 (6.9)
Delayed Wound Healing	5 (6.9)
Hematoma/Seroma	5 (6.9)
Hypertrophic Scarring	3 (4.2)
Asymmetry	2 (2.8)
Breast Cancer	2 (2.8)
Extrusion	2 (2.8)
Implant Malposition/Displacement	2 (2.8)
Ptosis	2 (2.8)
Infection	1 (1.4)
Patient Dissatisfied with Appearance	1 (1.4)
Rupture	1 (1.4)
Shape Change	1 (1.4)
Skin Lesions	1 (1.4)
Suspected Rupture	1 (1.4)
Unknown	1 (1.4)
Wrinkling	1 (1.4)

<sup>1</sup> All reoperations were counted, with the primary reason for each reoperation presented.

Through 6 years, there were 194 additional surgical procedures performed in 110 reoperations involving 82 primary reconstruction patients. The most common reason for reoperation through 6 years was asymmetry (18 of 110 reoperations). Table 5c below provides the main reasons for the reoperations following initial implantation through 6 years for primary reconstruction patients.

**Table 5c. Main Reasons for Reoperation for Primary Reconstruction Cohort**

<b>Primary Reason for Reoperation</b>	<b>Year 6 N=110 Reoperations<sup>1</sup> n (%)</b>
Asymmetry	18 (16.4)
Breast Mass	15 (13.6)
Capsular Contracture III/IV	15 (13.6)
Implant Malposition	9 (8.2)
Size Change	9 (8.2)
Ptosis	4 (3.6)
Hematoma/Seroma	4 (3.6)
Infection	4 (3.6)
Rupture	4 (3.6)
Extrusion/Necrosis	3 (2.7)
Breast Pain	2 (1.8)
Capsular Contracture II	2 (1.8)
Hypertrophic Scarring	2 (1.8)
Lack of Projection	2 (1.8)
Nipple Related (unplanned)	2 (1.8)
Metastatic Disease	2 (1.8)
Breast Cancer	1 (0.9)
Delayed Wound Healing	1 (0.9)
Extra Skin Bump	1 (0.9)
Lymphadenopathy	1 (0.9)
Muscle Spasm	1 (0.9)
Patient Dissatisfied with Appearance	1 (0.9)
Recurrent Breast Cancer	1 (0.9)
Breast/Skin Lesions	1 (0.9)
Stitch Abscess	1 (0.9)
Suspected Rupture	1 (0.9)
Suture Complication	1 (0.9)
Unknown	1 (0.9)
Wide Scar	1 (0.9)

<sup>1</sup> All reoperations were counted, with the primary reason for each reoperation presented.

Through 6 years, there were 72 additional surgical procedures performed in 33 reoperations involving 20 revision-reconstruction patients. The most common reason for reoperation through 6 years was breast mass (6 of 33 reoperations). Table 5d below provides the main reason for each reoperation following initial implantation through 6 years for revision-reconstruction patients.

**Table 5d. Main Reasons for Reoperation for Revision-Reconstruction Cohort**

Primary Reason for Reoperation	Year 6 N=33 Reoperations <sup>1</sup> n (%)
Breast Mass	6 (18.2)
Capsular Contracture III/IV	5 (15.2)
Ptosis	3 (9.1)
Breast/Skin Lesions	3 (9.1)
Asymmetry	2 (6.1)
Breast Cancer	2 (6.1)
Size Change	2 (6.1)
Suspected Rupture	2 (6.1)
Symmastia	2 (6.1)
Breast Pain	1 (3.0)
Capsular Tear	1 (3.0)
Extrusion	1 (3.0)
Hematoma	1 (3.0)
Metastatic Disease	1 (3.0)
Wrinkling	1 (3.0)

<sup>1</sup> All reoperations were counted, with the primary reason for each reoperation presented.

### **Main Reasons for Breast Implant Removal**

The main reasons for implant removal among primary augmentation patients in the MemoryGel™ Breast Implant Core Study through 6 years are shown in Table 6a below. There were 64 implants removed in 36 patients through 6 years. Of these 64 implants, 33 (52%) were replaced with a study device. The most common reason for implant removal was patient requested size change (34 of the 64 implants removed).

**Table 6a. Main Reasons for Breast Implant Removal for Primary Augmentation Cohort**

Reasons for Implant Removal	Year 6 N=64 Implants Removed n (%)
Size Change	34 (53.1)
Capsular Contracture III/IV	13 (20.3)
Patient Request	6 (9.4)
Breast Pain	3 (4.7)
Infection	2 (3.1)
Necrosis	2 (3.1)
Asymmetry	1 (1.6)
Rupture	1 (1.6)
Wrinkling	1 (1.6)
Suspected Rupture	1 (1.6)

The main reasons for implant removal among revision-augmentation patients in the MemoryGel™ Breast Implant Core Study through 6 years are shown in Table 6b below. There were 45 implants removed in 25 patients through 6 years. Of these 45 implants, 21 (47%) were replaced with a study device. The most common reason for implant removal was patient requested size change (15 of the 45 implants removed).

**Table 6b. Main Reasons for Breast Implant Removal for Revision-Augmentation Cohort**

Reasons for Implant Removal	Year 6 N=45 Implants Removed n (%)
Size Change	15 (33.3)
Capsular Contracture III/IV	13 (28.9)
Asymmetry	2 (4.4)
Breast Cancer	2 (4.4)
Rupture	2 (4.4)
Patient Dissatisfied with Appearance	2 (4.4)
Shape Change	2 (4.4)
Breast Mass	1 (2.2)
Capsular Contracture II	1 (2.2)
Extrusion	1 (2.2)
Hypertrophic Scarring	1 (2.2)
Infection	1 (2.2)
Suspected Rupture	1 (2.2)
Wrinkling	1 (2.2)

The main reasons for implant removal among primary reconstruction patients in the Mentor® MemoryGel™ Breast Implant Core Study through 6 years are shown in Table 6c below. There were 56 implants removed in 42 patients through 6 years. Of these 56 implants, 26 (46%) were replaced with a study device. The most common reason for implant removal was size change (16 of the 56 implants removed).

**Table 6c. Main Reasons for Breast Implant Removal for Primary Reconstruction Cohort**

<b>Reasons for Implant Removal</b>	<b>Year 6 N=56 Implants Removed n (%)</b>
Size Change	16 (28.6)
Asymmetry	12 (21.4)
Capsular Contracture III/IV	8 (14.3)
Rupture	4 (7.1)
Implant Malposition/Displacement	3 (5.4)
Patient Dissatisfied with Appearance	2 (3.6)
Breast Pain	2 (3.6)
Extrusion	2 (3.6)
Infection	2 (3.6)
Hematoma	1 (1.8)
Lack of Projection	1 (1.8)
Metastatic Disease	1 (1.8)
Muscle Spasm	1 (1.8)
Ptosis	1 (1.8)

The main reasons for implant removal among revision-reconstruction patients in the Mentor® MemoryGel™ Breast Implant Core Study through 6 years are shown in Table 6d below. There were 20 implants removed in 14 patients through 6 years. Of these 20 implants, 13 (65%) were replaced with a study device. The most common reason for implant removal was capsular contracture III/IV (5 of the 20 implants removed).

**Table 6d. Main Reasons for Breast Implant Removal for Revision-Reconstruction Cohort**

<b>Reasons for Implant Removal</b>	<b>Year 6 N=20 Implants Removed n (%)</b>
Capsular Contracture III/IV	5 (25.0)
Size Change	4 (20.0)
Asymmetry	4 (20.0)
Symmastia	2 (10.0)
Breast Pain	1 (5.0)
Capsular Tear	1 (5.0)
Extrusion	1 (5.0)
Ptosis	1 (5.0)
Suspected Rupture	1 (5.0)

## Other Clinical Data Findings

Below is a summary of clinical findings from Mentor's MemoryGel™ Breast Implant Core Study with regard to connective tissue disease (CTD), CTD signs and symptoms, cancer, lactation complications, reproduction complications, and suicide. These issues, along with other endpoints, are being further evaluated as part of the MENTOR® MemoryGel™ Breast Implants post-approval study.

### CTD Diagnoses

In the MemoryGel™ Breast Implant Core Study through 6 years, there were 7 primary augmentation patients, 3 revision-augmentation patients, 3 primary reconstruction patients, and 5 revision-reconstruction patients reported to have a new diagnosis of CTD by a rheumatologist. There were 9 diagnoses for the 7 primary augmentation patients: carpal tunnel syndrome (within 5 years), chronic fatigue (within 1 year), fibromyalgia (2 cases – within 3 and 4 years), Hashimoto's thyroiditis (within 2 years), hypothyroidism (within 2 years), other inflammatory arthritis (within 5 years), systemic lupus erythematosus (within 4 years), and thyroiditis (within 2 years). There were 3 diagnoses for the 3 revision-augmentation patients: celiac disease (within 6 years), fibromyalgia (within 3 years), and rheumatoid arthritis (within 3 years). There were 5 diagnoses for the 3 primary reconstruction patients: chronic fatigue (within 5 years), cold urticaria (within 4 years), fibromyalgia (2 cases – within 1 and 5 years), and other inflammatory arthritis (within 5 years). There were 5 diagnoses for the 5 revision-reconstruction patients: fibromyalgia (within 1 year), other connective tissue disorder (within 3 years), other inflammatory arthritis (2 cases – within 4 and 5 years), and pyoderma gangrenosum (within 1 year). It cannot be concluded that these CTD diagnoses were caused by the implants because there was no comparison group of similar women without implants.

### CTD Signs and Symptoms

Compared to before having implants, the following significant changes in individual signs and symptoms were found in the rheumatologic symptoms and physical examination findings after adjusting for the age effect: an increase for combined pain among primary augmentation patients and an increase for joint pain and fatigue among overall patients. No statistically significant differences for individual signs and symptoms were found for the revision-augmentation, primary reconstruction, and revision-reconstruction patients. For sign/symptom categories, the only statistically significant result was for the central nervous system category for primary reconstruction patients.

The MemoryGel™ Breast Implant Core Study was not designed to evaluate cause and effect associations because there is no comparison group of women without implants, and because other contributing factors, such as medications and lifestyle/exercise, were not studied. Therefore, it cannot be determined whether these changes were due to the implants or not, based on the MemoryGel™ Breast Implant Core Study. However, your patient should be aware that she may experience an increase in these types of symptoms after receiving breast implants.

### Cancer

For primary augmentation patients, there were no new diagnoses of breast cancer through 6 years in Mentor's MemoryGel™ Breast Implant Core Study. As previous breast cancer was an exclusion criterion



for primary augmentation patients, there were no reports of breast cancer recurrence in this cohort. For revision-augmentation patients, 2 (1.4%) patients had a new diagnosis of breast cancer. For primary reconstruction patients, 3 (1.2%) patients had a new diagnosis of breast cancer and 2 (0.8%) patients had a recurrence of breast cancer. For revision-reconstruction, 1 (1.7%) patient had a new diagnosis of breast cancer and there were no reports of a recurrence of breast cancer.

Through 6 years, there were no reports of other new cancers, such as brain, respiratory, or cervical/vulvar in any cohort. In addition, through 6 years, there were no cases of ALCL in any cohort.

### **Lactation Complications**

Ten of the 61 primary augmentation patients who attempted to breastfeed following breast implantation experienced difficulty with breastfeeding through 6 years in Mentor's MemoryGel™ Breast Implant Core Study. Two of the 10 of the revision-augmentation patients who attempted to breastfeed after receiving breast implants experienced difficulty. Seven primary reconstruction (non-mastectomy) patients attempted to breastfeed and 1 experienced difficulty. None of the revision-reconstruction patients attempted to breastfeed.

### **Reproduction Complications**

Sixteen primary augmentation patients, 3 revision-augmentation patients, and 6 primary reconstruction patients reported a miscarriage through 6 years. There were no reports of miscarriage in the revision-reconstruction cohort.

### **Suicide**

There were no reports of suicide in any of the cohorts in Mentor's MemoryGel™ Breast Implant Core Study through 6 years.

### **DEVICE IDENTIFICATION CARD**

Enclosed with each silicone gel breast implant is a Patient ID Card. To complete the Patient ID Card, place one device identification sticker (Patient Record Label) for each implant on the back of the card. Stickers are located on the internal product packaging attached to the label. If a sticker is unavailable, the lot number, catalog number, and description of the device may be copied by hand from the device label. Patients should be provided with these cards for personal reference.

### **DEVICE RETRIEVAL EFFORTS**

Mentor requests that any explanted devices be sent to the Mentor Complaint Department for examination and analysis. For instructions on the return of the explanted devices, please call 1-866-250-5115 or send an email to RA-MNTUS-Intake@its.jnj.com prior to sending any devices back to Mentor.

## **PRODUCT EVALUATION**

Mentor requires that any complication and/or explanation resulting from the use of this device be brought to the immediate attention of your local Mentor representative, who will be responsible for informing the Mentor Complaint Department. If explanation is necessary, analysis will be performed on the explanted device and the patient and the physician must be asked for permission to allow tests to be performed which might alter the condition of the device.

## **HOW TO REPORT PROBLEMS WITH AN IMPLANT**

FDA requires that serious injuries (defined as those that need medical or surgical intervention to prevent permanent damage) be reported by hospitals if they are aware of the serious injuries. In addition, injuries or complications can be voluntarily reported directly by the patient to FDA's MedWatch.

If you have a patient who has experienced one or more serious problems related to her breast implants, you are encouraged to report the serious problem(s) to FDA through the MedWatch voluntary reporting system. Examples of serious problems include disability, hospitalization, harm to offspring, and medical or surgical intervention to prevent lasting damage.

You are also required to report any product problem or serious adverse event to Mentor. Deaths must be reported to Mentor and FDA. You can report by telephone to 1-800-FDA-1088 by FAX, use Form 3500 to 1-800-FDA-0178 electronically at <http://www.fda.gov/medwatch/index.html> or by mail to:

MedWatch Food and Drug Administration, HF-2  
5600 Fishers Lane  
Rockville, MD 20857-9787

### **Keep a copy of the completed MedWatch form for your records.**

This information reported to MedWatch is entered into databases to be used to follow safety trends (patterns) of a device and to determine whether further follow-up of any potential safety issues related to the device is needed.

**RETURNED GOODS AUTHORIZATION****U.S. Customers**

Merchandise returned must have all manufacturers' seals intact and must be returned within 60 days from date of invoice to be eligible for credit or replacement. Please contact the Mentor Customer Service Department for details. Returned products may be subject to restocking charges.

**International Customers**

Authorization for return of merchandise should be obtained from your local Mentor representative prior to the return of the merchandise. Merchandise must have all manufacturer's seals intact to be eligible for credit or replacement. Returned products may be subject to a restocking charge.

**PRODUCT REPLACEMENT POLICY AND ADVANTAGE LIMITED WARRANTIES**

Mentor's Lifetime Product Replacement Policy and Advantage Limited Warranties provide limited replacement and limited financial reimbursement in the event of shell leakage or breakage resulting in breast implant rupture. For more information, please contact Mentor's Consumer Affairs Department at (866) 250-5115 or visit [www.mentorwwllc.com](http://www.mentorwwllc.com).

---

## REFERENCES

1. FDA. 2010. Tracking obligations of persons other than device manufacturers: distributor requirements 21 Code of Federal Regulations (CFR) §821.30.
2. Hurst, N.M. 1996. Lactation after augmentation mammoplasty. *Obstet. Gynecol.* 87(1):30-4.
3. Bondurant, S., V.L. Ernster and R. Herdman, Eds. 2000. Safety of silicone breast implants. Committee on the Safety of Silicone Breast Implants, Division of Health Promotion and Disease Prevention, Institute of Medicine. Washington, D.C.: National Academy Press.
4. Henriksen, T.F., et al. 2005. Surgical intervention and capsular contracture after breast augmentation: a prospective study of risk factors. *Ann. Plast. Surg.* 54(4):343-51.
5. Kulmala, I., et al. 2004. Local complications after cosmetic breast implant surgery in Finland. *Ann. Plast. Surg.* 53(5):413-9.
6. American Academy of Pediatrics (AAP) Committee on Drugs. 2001. Transfer of drugs and other chemicals into human milk. *Pediatrics* 108, 776-789.
7. Independent Review Group (IRG). 1998. Silicone Gel Breast Implants: Report of the IRG (United Kingdom).
8. Pinsolle, V., Grinfeder, C., Mathoulin-Pelissier, S. & Faucher, A. 2006. Complications analysis of 266 immediate breast reconstructions. *J Plast Reconstr Aesthet Surg.* 56:1017-1024.
9. Whitfield, G. A. et al. 2009. Incidence of severe capsular contracture following implant based immediate breast reconstruction with or without postoperative chest wall radiotherapy using 40 Gray in 15 fractions. *Radiother Oncol* 90:141-147.
10. Kronowitz, S. J. & Robb, G. L. 2009. Radiation therapy and breast reconstruction: a critical review of the literature. *Plast Reconstr Surg* 124:395-408.
11. Brown, S. L., Duggirala, H. J. & Pennello, G. 2002. An association of silicone-gel breast implant rupture and fibromyalgia. *Curr Rheumatol Rep.* 4:293-298.
12. Brown, S.L., et al. 2001. Silicone gel breast implant rupture, extracapsular silicone, and health status in a population of women. *J. Rheumatol.* 28:996-1003.
13. Gaubitz, M., Jackisch, C., Domschke, W., Heindel, W. & Pfeleiderer, B. 2002. Silicone breast implants: correlation between implant ruptures, magnetic resonance spectroscopically estimated silicone presence in the liver, antibody status and clinical symptoms. *Rheumatology (Oxford)* 41:129-135; discussion 123-124.
14. Hölmich, L. R. et al. 2003. Self-reported diseases and symptoms by rupture status among unselected Danish women with cosmetic silicone breast implants. *Plast Reconstr Surg* 111:723-732; discussion 733-4.
15. Hölmich, L.R., et al. 2004. Untreated silicone breast implant rupture. *Plast. Reconstr. Surg.* 114:204-214.
16. Collis, N., et al. 2007. Magnetic Resonance Imaging and Explantation Investigation of Long-Term Silicone Gel Implant Integrity. *Plast. Reconstr. Surg.* 120(5):1401-1406.
17. Hölmich, L.R., et al. 2001. Prevalence of silicone breast implant rupture among Danish women. *Plast. Reconstr. Surg.* 108(4):848-858.
18. Katzin, W.E., et al. 2005. Pathology of lymph nodes from patients with breast implants: a histologic and spectroscopic evaluation. *Am J Surg Pathol.* 29(4):506-11.
19. Berner, I.M., et al. 2002. Comparative examination of complaints of patients with breast-cancer with and without silicone implants. *Eur. J Obstet. Gynecol. Reprod. Biol.* 102:61-66.
20. Wolfe, F. and J. Anderson. 1999. Silicone filled breast implants and the risk of fibromyalgia and rheumatoid arthritis. *J. Rheumatol.* 26:2025-2028.

21. Brinton, L.A., et al. 2004. Risk of connective tissue disorders among breast implant patients. *Am. J. Epidemiol.* 160(7):619-27.
22. Janowsky, E.C., et al. 2000. Meta-Analyses of the Relation Between Silicone Breast Implants and the Risk of Connective-Tissue Diseases. *N. Engl. J. Med.* 342(11):781-90.
23. Lipworth et al. 2011. Silicone breast implants and connective tissue disease: no association. *Semin. Immunopathol.* 33(3):287-294.
24. Tugwell, P., et al. 2001. Do silicone breast implants cause rheumatologic disorders? A systematic review for a court-appointed national science panel. *Arthritis Rheum.* 11:2477-84.
25. Weisman, M.H., et al. 1988. Connective-tissue disease following breast augmentation: A preliminary test of the human adjuvant tissue hypothesis. *Plast. Reconstr. Surg.* 82(4):626-30.
26. Williams, H.J., et al. 1997. Breast implants in patients with differentiated and undifferentiated connective tissue disease. *Arthritis and Rheumatism* 40(3):437-40.
27. Vermeulen, R. C. & Scholte, H. R. 2003. Rupture of silicone gel breast implants and symptoms of pain and fatigue. *J Rheumatol* 30:2263-2267.
28. Breiting, V.B., et al. 2004. Long-term health status of Danish women with silicone breast implants. *Plast. Reconstr. Surg.* 114:217-26.
29. Fryzek, J.P., et al. 2001. Self-reported symptoms among women after cosmetic breast implant and breast reduction surgery. *Plast. Reconstr. Surg.* 107:206-13.
30. Kjoller, K., et al. 2004. Self-reported musculoskeletal symptoms among Danish women with cosmetic breast implants. *Ann Plast Surg.* 52(1):1-7.
31. Brinton, L.A., et al. 2000. Breast cancer following augmentation mammoplasty (United States). *Cancer Causes Control.* 11(9):819-27. *J. Long Term Eff. Med. Implants.* 12(4):271-9.
32. Brinton LA, et al. 2006. Mortality rates among augmentation mammoplasty patients: An update. *Epidemiology.* 17(2):162-9.
33. Deapen, D. M., Hirsch, E. M. & Brody, G. S. 2007. Cancer risk among Los Angeles women with cosmetic breast implants. *Plast Reconstr Surg* 119, 1987-1992.
34. Herdman, R.C., et al. 2001. Silicone breast implants and cancer. *Cancer Invest.* 19(8):821-32.
35. Pukkala, E., et al. 2002. Incidence of breast and other cancers among Finnish women with cosmetic breast implants, 1970-1999. *J. Long Term Eff. Med. Implants* 12(4):271-9.
36. Deapen, D., et al. 2000. Breast cancer stage at diagnosis and survival among patients with prior breast implants. *Plast Reconstr Surg.* 105(2):535-40.
37. Jakubietz, M.G., et al. 2004. Breast augmentation: Cancer concerns and mammography – A literature review. *Plast. Reconstr. Surg.* 113:117e 122e.
38. Miglioretti, D.L., et al. 2004. Effect of breast augmentation on the accuracy of mammography and cancer characteristics. *J. Amer. Med Assoc.* 291(4):442-50.
39. Hölmich, L. R. et al. 2003. Stage of breast cancer at diagnosis among women with cosmetic breast implants. *Br J Cancer* 88:832-838.
40. Jakub, J. W. et al. 2004. Breast cancer in patients with prior augmentation: presentation, stage, and lymphatic mapping. *Plast Reconstr Surg.* 114:1737-1742.
41. Brinton, L.A., et al. 2001. Cancer risk at sites other than the breast following augmentation mammoplasty. *Ann. Epidemiol.* 11:248-56.

42. McLaughlin, J.K., and L. Lipworth. 2004. Brain cancer and cosmetic breast implants: A review of the epidemiological evidence. *Ann. Plast. Surg.* 52(2):15-17.
43. Brisson, J. et al. 2006. Cancer incidence in a cohort of Ontario and Quebec women having bilateral breast augmentation. *Int J Cancer* 118: 2854-2862.
44. Friis, S. et al. 2006. Cancer risk among Danish women with cosmetic breast implants. *Int J Cancer* 118:998-1003.
45. McLaughlin, J. K. et al. 2006. Long-term cancer risk among Swedish women with cosmetic breast implants: an update of a nationwide study. *J Natl Cancer Inst* 98:557-560.
46. Mellekjaer, L. et al. 2000. Cancer occurrence after cosmetic breast implantation in Denmark. *Int J Cancer* 88:301-306.
47. Cook, L.S. 1997. Characteristics of women with and without breast augmentation. *J. Amer. Med. Assoc.* 20:1612-7.
48. Fryzek, J.P., et al. 2000. Characteristics of women with cosmetic breast augmentation surgery compared with breast reduction surgery patients and women in the general population of Sweden. *Ann Plast Surg.* 45(4):349-56.
49. Kj ller, K., et al. 2003. Characteristics of women with cosmetic breast implants compared with women with other types of cosmetic surgery and population-based controls in Denmark. *Ann Plast Surg.* 50(1):6-12.
50. de Jong, D. et al. 2008. Anaplastic large-cell lymphoma in women with breast implants. *Jama* 300, 2030-2035 (2008).
51. Brinton, L.A., et al. 2001. Mortality among augmentation mammoplasty patients. *Epidemiology.* 12(3):321-6.
52. Jacobsen, P.H., et al. 2004. Mortality and suicide among Danish women with cosmetic breast implants. *Arch. Int. Med.* 164(22):2450-5.
53. Koot, V., et al. 2003. Total and cost specific mortality among Swedish women with cosmetic breast implants: prospective study. *Br. J. Med.* 326(7388):527-528.
54. Pukkala, E., et al. 2003. Causes of death among Finnish women with cosmetic breast implants, 1971-2001. *Ann. Plast. Surg.* 51(4):339-42.
55. Lugowski, S.J., et al. 2000. Analysis of silicon in human tissues with special reference to silicone breast implants. *J. Trace Elem. Med. Biol.* 14(1):31-42.
56. Kj ller, K., et al. 2002. Health outcomes in offspring of Danish mothers with cosmetic breast implants. *Ann. Plast. Surg.* 48:238-245.
57. Signorello, L.B., et al. 2001. Offspring health risk after cosmetic breast implantation in Sweden. *Ann. Plast. Surg.* 46:279-286.
58. Hemminki, E., et al. 2004. Births and perinatal health of infants among women who have had silicone breast implantation in Finland, 1967-2000. *Acta Obstet Gynecol Scand.* 83(12):1135-40.
59. Flassbeck, D.B., et al. 2003. Determination of siloxanes, silicon, and platinum in tissues of women with silicone gel-filled implants. 375(3):356-62 (for example, data from Patients B & C).
60. Stein, J., et al. 1999. In situ determination of the active catalyst in hydrosilylation reactions using highly reactive Pt(0) catalyst precursors. *J. Am. Chem. Soc.* 121(15):3693-3703. Chandra, G., et al. 1987. A convenient and novel route to bis(alkyne)platinum(0) and other platinum(0) complexes from Speier's hydrosilylation catalyst. *Organometallics.* 6:191-2. Lappert, M.F. and Scott, F.P.A. 1995. The reaction pathway from Speier's to Karstedt's hydrosilylation catalyst. *J. Organomet. Chem.* 492(2):C11-C13. Lewis, L.N., et al. 1995. Mechanism of formation of platinum(0) complexes containing silicon-vinyl ligands. *Organometallics.* 14:2202-13.
61. Balk, E.M., et al. 2015. Long-term health outcomes in women with silicone gel breast implants: a systematic review. [Doi:10.7326/M15-1169](https://doi.org/10.7326/M15-1169) [Epub ahead of print].

This page is intentionally left blank.



## SYMBOLS GLOSSARY

ISO 15223-1 Medical devices – Symbols to be used with medical device labels, labelling and information to be supplied

Title 21 Code of Federal Regulations Parts 801.109

	Serial number ISO 15223-1 Reference 5.1.7 Indicates the manufacturer's serial number so that a specific medical device can be identified.		Do not reuse ISO 15223-1 Reference 5.4.2 Indicates a medical device that is intended for one use, or for use on a single patient during a single procedure.		Not made with natural rubber latex
	Catalogue number ISO 15223-1 Reference 5.1.6 Indicates the manufacturer's catalogue number so that the medical device can be identified.		Do not resterilize ISO 15223-1 Reference 5.2.6 Indicates a medical device that is not to be resterilized.		Date of manufacturer ISO 15223-1 Reference 5.1.3 Indicates the date when the medical device was manufactured.
	Batch code ISO 15223-1 Reference 5.1.5 Indicates the manufacturer's batch code so that the batch or lot can be identified.		Caution ISO 15223-1 Reference 5.4.4 Indicates the need for the user to consult the instructions for use for important cautionary information such as warnings and precautions that cannot, for a variety of reasons, be presented on the medical device itself.		Manufacturer ISO 15223-1 Reference 5.1.1 Indicates the medical device manufacturer, as defined in EU Directives 90/385/EEC, 93/42/EEC and 98/79/EC.
	Use-by date ISO 15223-1 Reference 5.1.4 Indicates the date after which the medical device is not to be used.		Consult instructions for use ISO 15223-1 Reference 5.4.3 Indicates the need for the user to consult the instructions for use.		Caution: Federal (U.S.A.) law restricts this device to sale by or on the order of a licensed healthcare practitioner. Title 21 Code of Federal Regulations Parts 801.109
	Diameter, Projection		Sterilized using steam or dry heat ISO 15223-1 Reference 5.2.5 Indicates a medical device that has been sterilized using steam or dry heat.		
	Not returnable if opened		Non-pyrogenic ISO 15223-1 Reference 5.6.3 Indicates a medical device that is non-pyrogenic.		



For customer service, please call (800) 235-5731 in USA or contact your local representative.

[www.mentorwwllc.com](http://www.mentorwwllc.com) • [www.mentordirect.com](http://www.mentordirect.com)



**Manufacturer**  
MENTOR  
3041 Skyway Circle North  
Irving, TX 75038-3540 USA  
972-252-6060

© Mentor Worldwide LLC 2013, 2018



# IFU PRINTING SPECIFICATION SHEET

PAGE LAYOUT

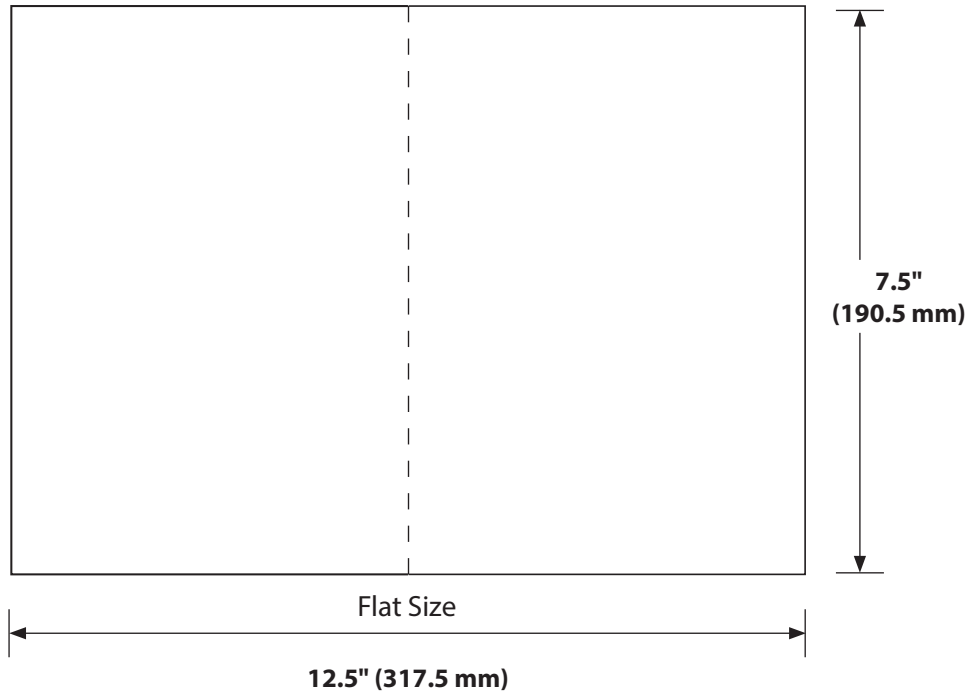

FOLD PATTERN

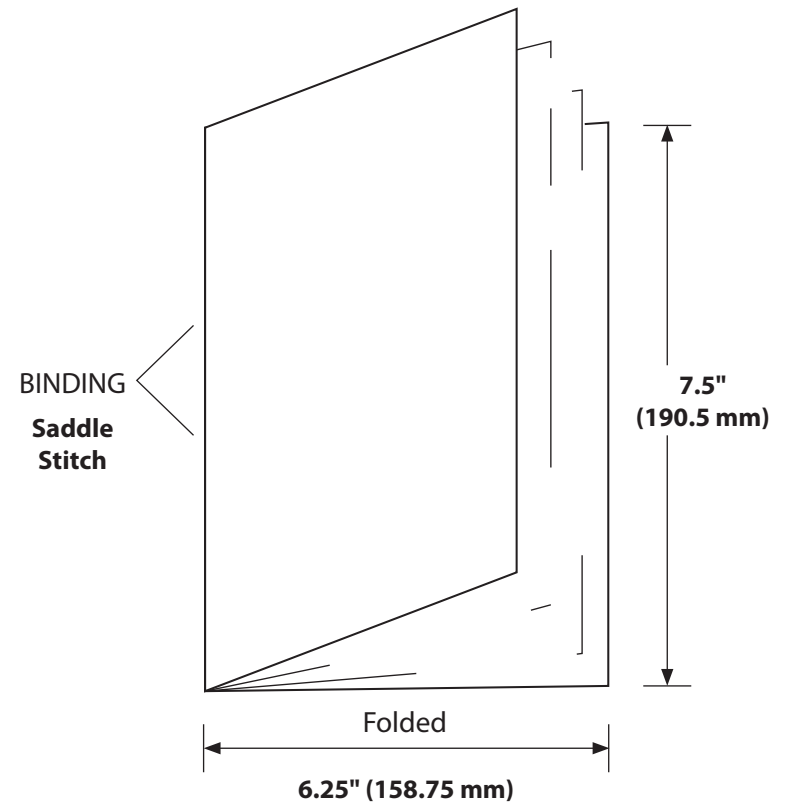

TITLE <b>MENTOR® MemoryGel™ Breast Implants</b>		DESCRIPTION <b>PIDS</b>		LAB NUMBER <b>LAB100524215v2</b>		SPECIAL INSTRUCTIONS/COMMENTS <b>n/a</b>		BINDING <b>Saddle Stitch</b>		COLORS <b>Black</b>		
FLAT SIZE <b>12.5" x 7.5" 317.5 mm x 190.5 mm</b>		FOLDED SIZE <b>6.25" x 7.5" 158.75 mm x 190.5 mm</b>		RMC NUMBER <b>112024-001 Rev B</b>	PAGE COUNT <b>48</b>	LANGUAGES <b>en</b>			SELF COVER <input checked="" type="checkbox"/>	PLUS COVER <input type="checkbox"/>	SEALING METHOD <b>n/a</b>	WAFER SEAL <input type="checkbox"/>
BLEED SIZE <input type="checkbox"/> .5" (12.7 mm) <input type="checkbox"/> .125" (3.175 mm)		NONE <input checked="" type="checkbox"/>	BLEED ALL SIDES <input type="checkbox"/>	BLEED TOP <input type="checkbox"/>	BLEED RIGHT <input type="checkbox"/>	BLEED LEFT <input type="checkbox"/>	BLEED BOTTOM <input type="checkbox"/>	<b>DRAWING IS NOT TO SCALE:</b> DRAWINGS REFLECT INFORMATION FOR PRODUCTION OF PRINTED PIECES AND DO NOT CONTAIN ACTUAL ARTWORK. This document or data herein or herewith is not to be reproduced, used or disclosed in whole or part without the permission of Ethicon, Inc.				
STOCK <b>50# White Offset</b>						<b>ETHICON</b>						